



 **FANIMATION®**  
SHOWROOM COLLECTION





## FANIMATION : AIR APPARENT

Fanimation's focus is producing creative and functional fans that provide ultimate personal comfort using the latest technology for energy efficiency and seamless control. From our humble beginnings in 1984, inside Founder and CEO Tom Frampton's Pasadena, California garage, ingenuity and quality craftsmanship have been central in every product we manufacture. Our timeless and inspired fans are sought across the globe.

You will find Fanimation in some of the most luxurious locales—from tropical resorts to the heart of your home.

# CHOOSING YOUR FAN

## LOCATION IS EVERYTHING

- Where you will install your fan is the first step in selecting the right fan for your space.
- Dry, indoor location: Choose from any of our fans—dry, damp or wet rated.
  - Outdoor covered or high-humidity indoor location: Choose from our damp or wet rated fans.
  - Outdoor location with likely direct contact with water: Choose from our wet rated fans.

**We've made it easy for you!**  
Look for these icons to identify location rating:



## SIZE MATTERS

The size of your room will help determine the size of your fan, identified by blade sweep. The following are general guidelines.

- Optimal performance will come from mounting your fan in the center of the room.
- If you have a long or large room, consider the use of multiple fans
- Scale is a personal preference. Large diameter fans can go in both small rooms and larger rooms—it's all in the look you desire.

**SMALL ROOM**  
52 in. or smaller

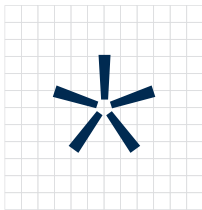

**LARGE ROOM**  
52 in. or larger

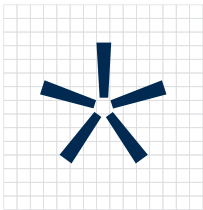

**GREAT ROOM**  
60 in. or larger

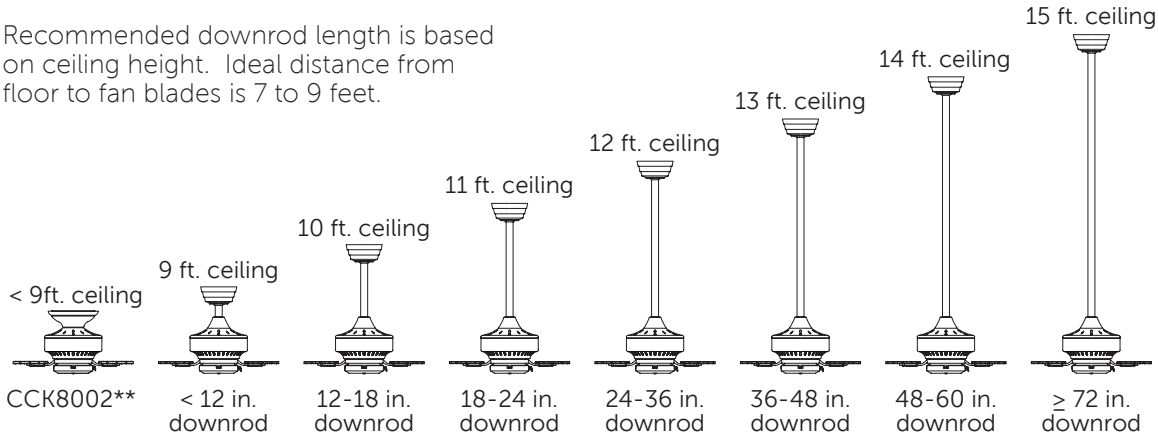
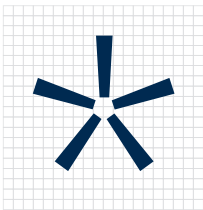



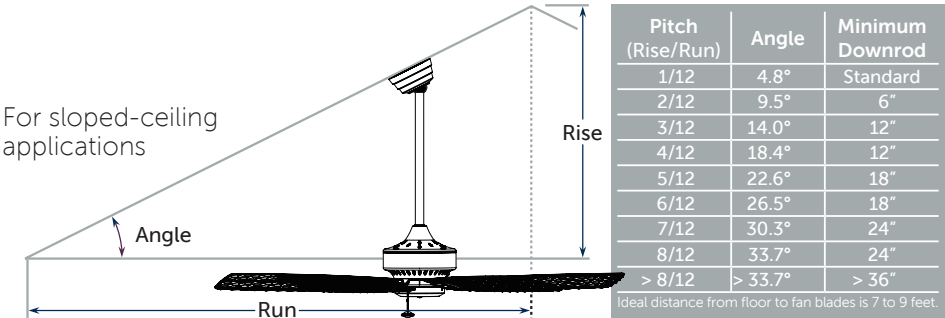







For lengths greater than 72 in., join two downrods with DR1-CP\*\* coupler





## IDENTIFYING FEATURES IMPORTANT TO YOU

We offer a diverse line of fans with equally diverse features. As you choose your fan, identify the features that matter to you—use Features Legend below to understand the Features icons.

fan control type				light kit included + lamping info	number of fan speeds + location of reversing switch	Bluetooth® control—if included or compatible	fan, blades and light sold separately	features energy-efficient DC motor	fan has earned the Energy Star
 <b>CONTROL</b> wall	 <b>CONTROL</b> remote	 <b>CONTROL</b> pull chain	 <b>CONTROL</b> rotary	 <b>WATTAGE</b> bulb style	 <b>SPEED</b> reverse location	 <b>FANSYNC™</b>			

## UNDERSTANDING AIRFLOW

We provide airflow information—at high speed—for each fan. Airflow is measured in CFM (cubic feet per minute), energy used is measured in watts and the energy efficiency of the fan is measured in CFM per watt.

### ENERGY INFORMATION AT HIGH SPEED:

Airflow	Electricity Use	Airflow Efficiency
<b>6942</b> Cubic Feet Per Minute	<b>65</b> Watts (excluding lights)	<b>107</b> Cubic Feet Per Minute Per Watt
The greater the number, the greater the air moved	Energy consumed	The greater the number, the more efficient the fan is

## FANIMATION MOTORS—AC AND DC

All Fanimation motors are built using high quality materials and components, insuring years of reliable and dependable operation for every Fanimation fan.

- Our fans are equipped with either an AC motor or DC motor.
- AC motors use supplied power directly and regulate speeds by controlling frequency.
- DC motors convert supplied power and regulate speeds by controlling electrical current.
- Our AC motors come in 1-, 3- and 4-speed variants.
- Our DC motors come in 6- and 31-speed variants. DC motors are more efficient, generate more torque and are virtually silent.

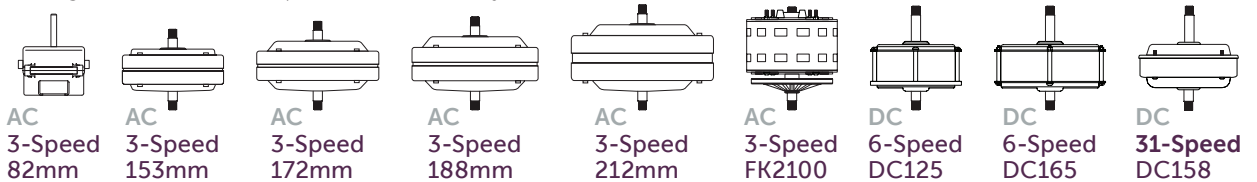

## SEASONAL CEILING FAN USE

Ceiling fans save money year-round when turning in the proper direction.

**WARM WEATHER**  
Airflow with counter-clockwise rotation, as you look up, provides a cooling breeze

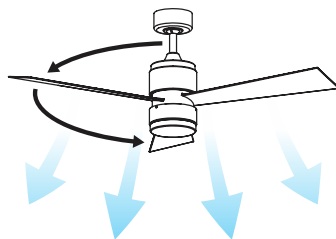

**COOL WEATHER**  
Airflow with clockwise rotation, as you look up, forces warm air downward

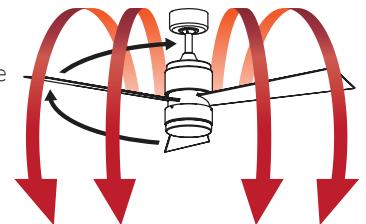

**Need more assistance? Call 1-888-567-2055**

INDOOR

AIRE DÉCOR  
96



AIRE DELUXE 44  
42



AIRE DELUXE 52  
44



BECKWITH  
18



BENITO  
30



BOURBON  
STREET  
53



CAMHAVEN  
32



CANCUN 42  
40



CELANO v2  
24



EDGEWOOD  
DECORATIVE  
46



EDGEWOOD  
DELUXE  
48



EDGEWOOD  
SUPREME  
50



EMBRACE 44  
12



EMBRACE 52  
14



ENIGMA  
60

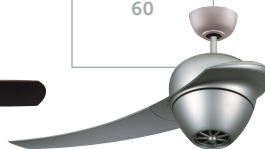

INLET  
16



KEISTONE  
34



KELLAN  
52



LEVON AC  
26



LOUVRE  
38



MAREA  
20



PALMETTO  
54



STAFFORD  
28



VENTANA  
36



ZONIX  
22



INDOOR/OUTDOOR

AIRE DÉCOR  
DAMP  
96



AMERICANA  
120



ASCENSION  
62



AVASTON  
92



BELLERIA  
112



BIG ISLAND  
118



BREWMASTER  
128



CANCUN WET  
102



CARUSO  
124

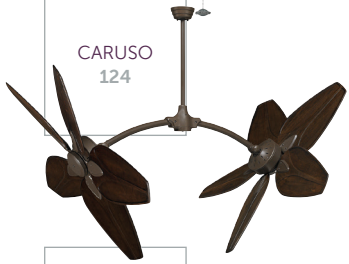

CRESTFORD  
106



EDGEWOOD  
DELUXE WET  
100

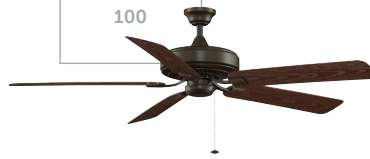

EDGEWOOD  
WET  
98



EXTRAORDINAIRE  
58



ISLANDER AC  
114



ISLANDER DC  
116



JENNIX  
94



KAYA  
104



LEVON  
CUSTOM  
84



LEVON DC  
82



My FANIMATION  
DISTINCTION AC  
66



My FANIMATION  
DISTINCTION DC  
72



ODYN  
80



PALISADE  
122

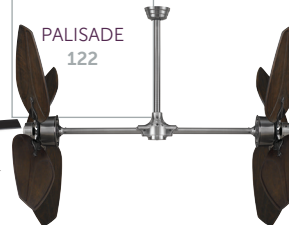

PUNKAH  
126



SPITFIRE  
86



SUBTLE  
78



TORTO  
88



TORTO LED  
90



INDOOR/OUTDOOR

WINDPOINTE  
108



WINDPOINTE  
CUSTOM  
110



XENO  
64



ZONIX LED  
76



ZONIX WET  
74

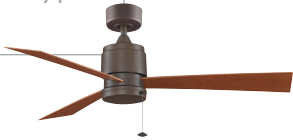

PORTABLES

ARDEN  
136



MINI BREEZE  
132



OLD HAVANA  
138



URBANJET  
134



ACCESSORIES

BLADES  
149



CONTROLS  
141



LIGHTING  
139



DOWNRODS &  
ACCESSORIES  
147





## TABLE OF CONTENTS

Aire Décor®.....	96	Levon™ DC.....	82
Aire Deluxe™ 44.....	42	Louvre®.....	38
Aire Deluxe™ 52.....	44	Marea™.....	20
Americana®.....	120	Mini Breeze™.....	132
Arden™.....	136	myFanimation™-Distinction™ AC.....	66
Ascension™.....	62	myFanimation™-Distinction™ DC.....	72
Avaston™.....	92	Odyn™.....	80
Beckwith™.....	18	Old Havana®.....	138
Belleria®.....	112	Palisade®.....	122
Benito™.....	30	Palmetto®.....	54
Big Island™.....	118	Punkah®.....	126
Bourbon Street®.....	53	Spitfire™.....	86
Brewmaster®.....	128	Stafford™.....	28
Camhaven™.....	32	Subtle™.....	78
Cancun™ 42.....	40	Torto™.....	88
Cancun™ Wet.....	102	Torto™ LED.....	90
Caruso™.....	124	Urbanjet™.....	134
Celano v2™.....	24	Ventana™.....	36
Crestford™.....	106	Windpointe®.....	108
Edgewood® Decorative.....	46	Windpointe® Custom.....	110
Edgewood® Deluxe.....	48	Xeno™.....	64
Edgewood® Deluxe Wet.....	100	Zonix™.....	22
Edgewood® Supreme.....	50	Zonix™ LED.....	76
Edgewood® Wet.....	98	Zonix™ Wet.....	74
Embrace™ 44.....	12	Choosing a Fan.....	3
Embrace™ 52.....	14	Lighting Kits.....	139
Enigma®.....	60	Fitters, Shades & Decorative Glass.....	140
Extraordinaire®.....	58	Remote Controls.....	141
Inlet™.....	16	Wall Controls.....	143
Islander® AC.....	114	Control Specifications.....	145
Islander® DC.....	116	Control Accessory.....	146
Jennix™.....	94	Downrods & Accessories.....	147
Kaya™.....	104	Bulb Reference.....	148
Keystone™.....	34	Blades.....	149
Kellan™.....	52	Antique Fan Museum.....	151
Levon™ AC.....	26	Index.....	153
Levon™ Custom.....	84		





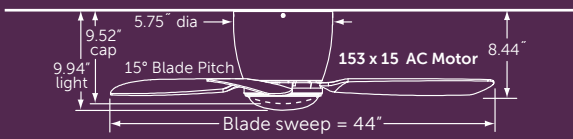

INDOOR



Net Hanging Weight: 18.9 lbs.

**FAN: FPS7981BN** (1)  
 brushed nickel assembly with  
 brushed nickel blades and  
 matching light cover (included)





**FAN: FPS7981DZ** (1)  
 dark bronze assembly with  
 dark bronze blades and  
 opal frosted glass





**FAN: FPS7981GR** (1)  
 matte greige assembly with  
 matte greige blades and  
 matching light cover (included)



**FAN: FPS7981MW** (1)  
 matte white assembly with  
 matte white blades and  
 opal frosted glass

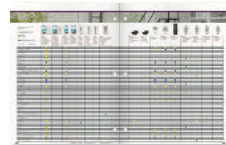

**SOLD SEPARATELY:**



See page 141-146 for  
optional controls

# EMBRACE™ 44

**FAN: FPS7981GR** (1)  
matte greige assembly  
with matte greige blades  
and opal frosted glass

brushed nickel	dark bronze	matte greige	matte white
brushed nickel	dark bronze	matte greige	matte white
<b>FPS7981BN</b>	<b>FPS7981DZ</b>	<b>FPS7981GR</b>	<b>FPS7981MW</b>

- (1) 100W halogen minican
- 3-SPEED AC reverse switch on remote
- CONTROL remote
- DRY indoor only

**INCLUDED:**

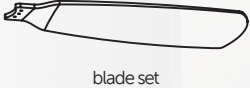

blade set



light kit

light cover



TR20WH remote

**ENERGY INFORMATION AT HIGH SPEED:**

Airflow	Electricity Use	Airflow Efficiency
<b>3855</b>	<b>45</b>	<b>87</b>
Cubic Feet Per Minute	Watts (excluding lights)	Cubic Feet Per Minute Per Watt

LIMITED LIFETIME MOTOR WARRANTY



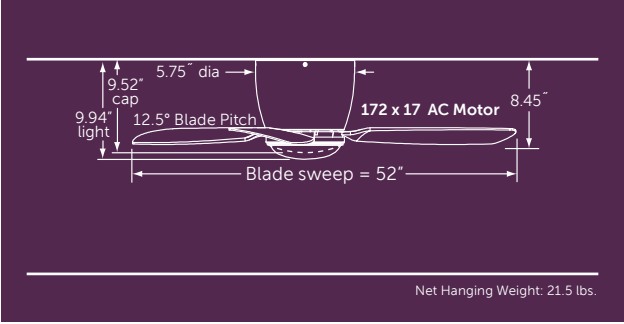

**FAN: FPS7955BN (1)**  
brushed nickel assembly with  
brushed nickel blades and  
matching light cover (included)



**FAN: FPS7955DZ (1)**  
dark bronze assembly with  
dark bronze blades and  
opal frosted glass



**FAN: FPS7955GR (1)**  
matte greige assembly with  
matte greige blades and  
matching light cover (included)



**FAN: FPS7955MW (1)**  
matte white assembly with  
matte white blades and  
opal frosted glass



**SOLD SEPARATELY:**

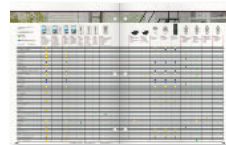

See page 141-146 for  
optional controls

# EMBRACE™ 52

**FAN: FPS7955DZ** (1)  
dark bronze assembly with  
dark bronze blades and  
opal frosted glass

brushed nickel	dark bronze	matte greige	matte white
brushed nickel	dark bronze	matte greige	matte white
<b>FPS7955BN</b>	<b>FPS7955DZ</b>	<b>FPS7955GR</b>	<b>FPS7955MW</b>



(1) 100W  
halogen  
minican



3-SPEED AC  
reverse switch  
on remote



CONTROL  
remote



DRY  
indoor only

## INCLUDED:



blade set



light kit



light cover



TR20WH remote

## ENERGY INFORMATION AT HIGH SPEED:

Airflow  
**5509**  
Cubic Feet  
Per Minute

Electricity Use  
**48**  
Watts  
(excluding lights)

Airflow Efficiency  
**114**  
Cubic Feet Per  
Minute Per Watt

LIMITED LIFETIME MOTOR WARRANTY



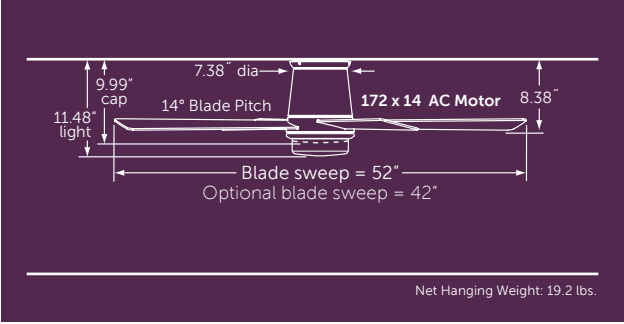

**FAN: FPS7880SN (1)**  
satin nickel assembly with  
cherry/walnut reversible  
blades and opal frosted glass  
● walnut side showing



**FAN: FPS7880OB (1)**  
oil-rubbed bronze assembly  
with cherry/walnut reversible  
blades and opal frosted glass  
● walnut side showing



**FAN: FPS7880SN (1)**  
satin nickel assembly with opal  
frosted glass  
**BLADE SET: BPW7823SN (1)**  
52" sweep all-weather composite  
satin nickel (sold separately)



**SOLD SEPARATELY:**

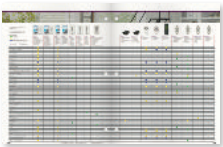

See page 141-146 for  
optional controls

CY—cherry  
SN—satin nickel  
WA—walnut

**BPW7880\*\*** composite

SN—satin nickel

**B7880SN** wood

CY—cherry  
SN—satin nickel  
WA—walnut

**BPW7823\*\*** composite



INLET™

**FAN: FPS7880SN** (1)  
satin nickel assembly with  
matching light cover (included)

**BLADE SET: BPW7880CY** (1)  
42" sweep all-weather composite  
cherry blades (sold separately)

oil-rubbed bronze	satin nickel
cherry walnut	cherry walnut
<b>FPS7880OB</b>	<b>FPS7880SN</b>



FANSYNC™  
compatible



(1) 18W  
GU24 CFL



3-SPEED AC  
reverse switch  
on remote



CONTROL  
remote



DRY  
indoor only

INCLUDED:

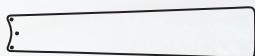

blade set



light kit  
light cover



TR20WH remote

ENERGY INFORMATION  
AT HIGH SPEED:

Airflow  
**5102**  
Cubic Feet  
Per Minute

Electricity Use  
**59**  
Watts  
(excluding lights)

Airflow Efficiency  
**86**  
Cubic Feet Per  
Minute Per Watt

LIMITED LIFETIME MOTOR WARRANTY



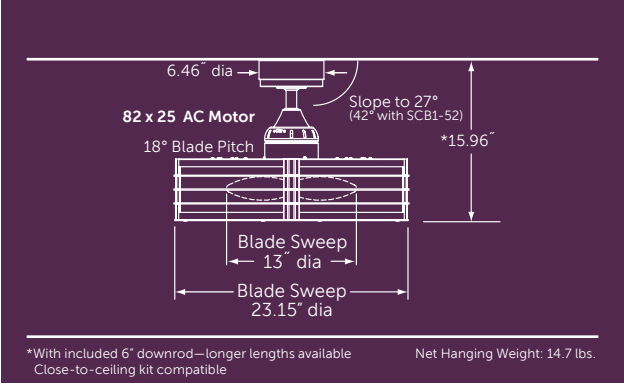

NOTE: THE LIGHT ON THE BECKWITH™ IS CONSIDERED AN ACCENT LIGHT AND IS NOT INTENDED TO BE USED AS A PRIMARY LIGHT SOURCE

**FAN: FP7964BN (1)**  
brushed nickel assembly  
with frosted white shade



**FAN: FP7964OB (1)**  
oil-rubbed bronze assembly  
with frosted white shade



SOLD SEPARATELY:

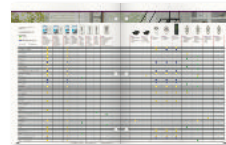

See page 141-146 for  
optional controls

# BECKWITH™



 **FAN: FP7964OB (1)**  
oil-rubbed bronze assembly  
with frosted white shade

brushed nickel	oil-rubbed bronze
aluminum	black
<b>FP7964BN</b>	<b>FP7964OB</b>

INCLUDED:



TR24WH remote



FANSYNC™  
compatible



(4) 43W  
halogen  
candelabra



3-SPEED AC  
reverse switch  
on fan



CONTROL  
remote



DRY  
indoor only

## ENERGY INFORMATION AT HIGH SPEED:

Airflow  
**1009**  
Cubic Feet  
Per Minute

Electricity Use  
**63**  
Watts  
(excluding lights)

Airflow Efficiency  
**16**  
Cubic Feet Per  
Minute Per Watt

LIMITED LIFETIME MOTOR WARRANTY



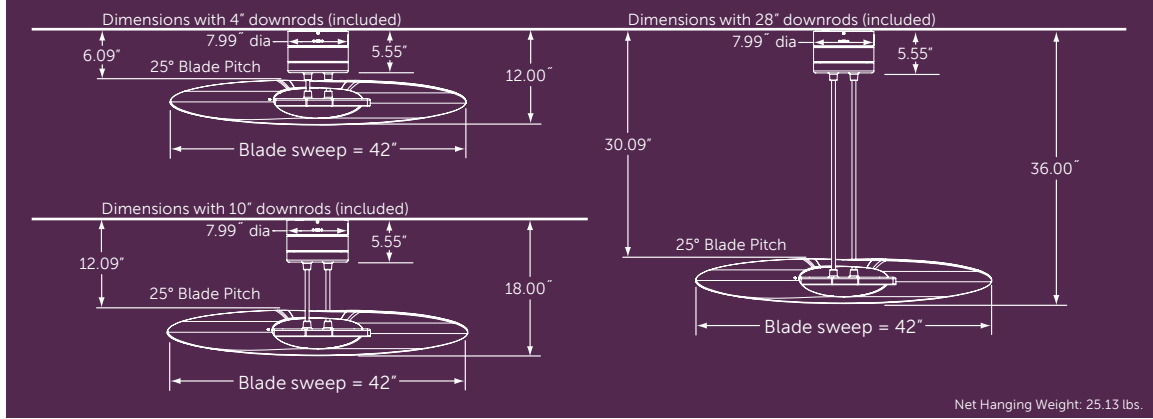

**FAN: FP8026SN (1)**  
 satin nickel assembly with  
 white frosted blade  
 • 28" downrod configuration

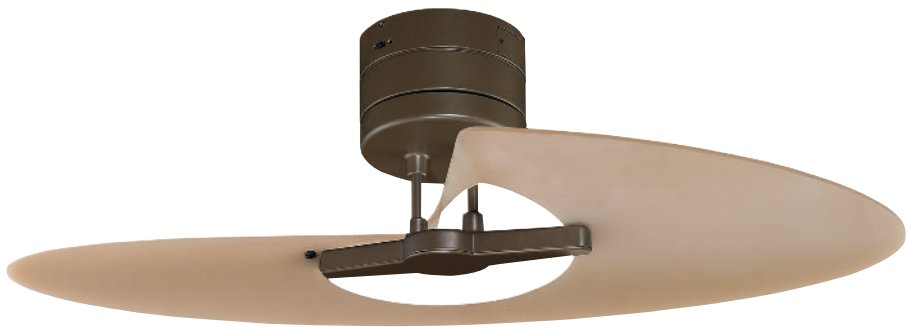

**FAN: FP8026OB (1)**  
 oil-rubbed bronze assembly  
 with amber frosted blade  
 • 4" downrod configuration

**SOLD SEPARATELY:**

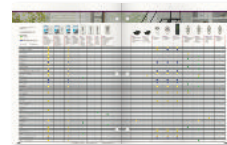

See page 141-146 for  
 optional controls

# MAREA™



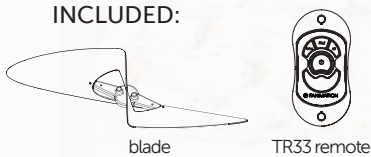

**FAN: FP8026OB (1)**  
 oil-rubbed bronze assembly  
 with amber frosted blade  
 • 4" downrod configuration

oil-rubbed bronze	satin nickel
amber frosted	white frosted
<b>FP8026OB</b>	<b>FP8026SN</b>

**INCLUDED:**



**ENERGY INFORMATION AT HIGH SPEED:**

 FANSYNC™ compatible	 3-SPEED AC reverse switch on fan	 CONTROL remote	 DRY indoor only
Airflow <b>3151</b> Cubic Feet Per Minute	Electricity Use <b>47</b> Watts (excluding lights)	Airflow Efficiency <b>67</b> Cubic Feet Per Minute Per Watt	

**LIMITED LIFETIME MOTOR WARRANTY**



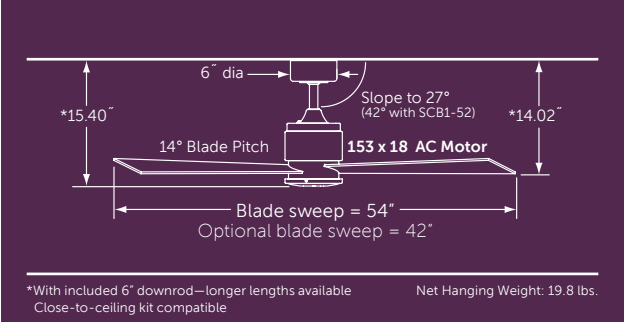

**FAN: FP4620BL (1)**  
black assembly with  
black wood blades



**FAN: FP4620BN (1)**  
brushed nickel assembly with  
reversible cherry/walnut wood blades  
● cherry side showing



**FAN: FP4620OB (1)**  
oil-rubbed bronze assembly with  
reversible cherry/walnut wood blades  
● cherry side showing



**FAN: FP4620PN (1)**  
polished nickel assembly with  
reversible cherry/walnut wood blades  
● walnut side showing



**FAN: FP4620SN (1)**  
satin nickel assembly with reversible  
cherry/walnut wood blades  
● cherry side showing



**FAN: FP4630SN (1)**  
satin nickel assembly with  
satin nickel wood blades



**SOLD SEPARATELY:**

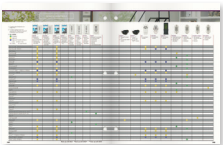

See page 141-146 for  
optional controls

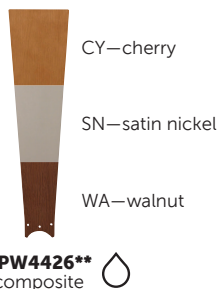

# ZONIX™

 **FAN: FP4620BL (1)**  
black assembly with  
black wood blades

black	brushed nickel	oil-rubbed bronze	polished nickel	satin nickel	satin nickel
black	cherry walnut	cherry walnut	cherry walnut	cherry walnut	satin nickel
<b>FP4620BL</b>	<b>FP4620BN</b>	<b>FP4620OB</b>	<b>FP4620PN</b>	<b>FP4620SN</b>	<b>FP4630SN</b>

INCLUDED:







blade set



CW40 wall control

ENERGY INFORMATION  
AT HIGH SPEED:

-  **FANSYNC™**  
compatible
-  **4-SPEED AC**  
reverse switch  
on fan
-  **CONTROL**  
wall
-  **DRY**  
indoor only

Airflow  
**4436**  
Cubic Feet  
Per Minute

Electricity Use  
**57**  
Watts  
(excluding lights)

Airflow Efficiency  
**78**  
Cubic Feet Per  
Minute Per Watt

LIMITED LIFETIME MOTOR WARRANTY



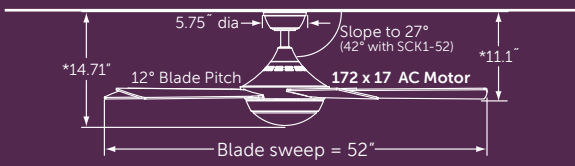

\*With included 4.5" downrod—longer lengths available  
Close-to-ceiling kit compatible

Net Hanging Weight: 18.74 lbs.



- FAN: FP8062BN (1)**  
brushed nickel assembly with  
frosted white glass and reversible  
cherry/dark walnut blades
- cherry side showing



- FAN: FP8062DZ (1)**  
dark bronze assembly with  
frosted glass and reversible  
cherry/dark walnut blades
- dark walnut side showing



- FAN: FP8062MW (1)**  
matte white assembly  
with frosted glass and  
matte white blades



**SOLD SEPARATELY:**

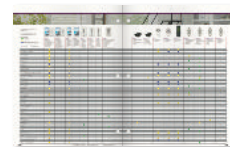

See page 141-146 for  
optional controls



# CELANO v2™

**FAN: FP8062BN (1)**  
brushed nickel assembly  
with cherry/dark walnut  
reversible blades.  
• dark walnut side showing

brushed nickel	dark bronze	matte white
cherry dark walnut	cherry dark walnut	matte white
<b>FP8062BN</b>	<b>FP8062DZ</b>	<b>FP8062MW</b>

  
**FANSYNC™**  
included

  
**18W**  
LED

  
**3-SPEED AC**  
reverse switch  
on fan

  
**CONTROL**  
remote

  
**DRY**  
indoor only

**INCLUDED:**

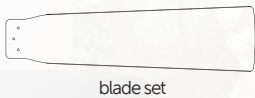

blade set



light kit



BTT9

**ENERGY INFORMATION**  
AT HIGH SPEED:

Airflow  
**5596**  
Cubic Feet  
Per Minute

Electricity Use  
**60**  
Watts  
(excluding lights)

Airflow Efficiency  
**93**  
Cubic Feet Per  
Minute Per Watt



**LIMITED LIFETIME MOTOR WARRANTY**



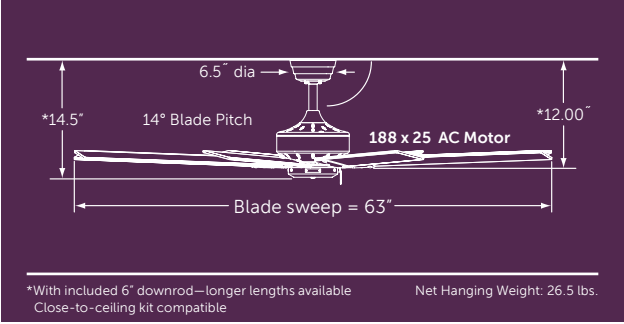

**FAN: FP7910BL (1)**  
 black assembly with black blades



**FAN: FP7910BN (1)**  
 brushed nickel assembly  
 with reversible cherry/walnut  
 wood blades  
 ● walnut side showing



**FAN: FP7910MW (1)**  
 matte white assembly with  
 matte white blades



**FAN: FP7910OB (1)**  
 oil-rubbed bronze assembly  
 with walnut blades



**SOLD SEPARATELY:**

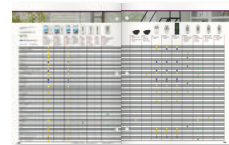

See page 141-146 for  
 optional controls

# LEVON™ AC



**FAN: FP7910BN (1)**  
brushed nickel assembly  
with reversible cherry/  
walnut wood blades  
● walnut side showing

brushed nickel	black	matte white	oil-rubbed bronze
cherry walnut	black	matte white	walnut
<b>FP7910BN</b>	<b>FP7910BL</b>	<b>FP7910MW</b>	<b>FP7910OB</b>



FANSYNC™  
compatible



3-SPEED AC  
reverse switch  
on fan



CONTROL  
pull chain



DRY  
indoor only

INCLUDED:



blade set

## ENERGY INFORMATION AT HIGH SPEED:

Airflow

**6942**

Cubic Feet  
Per Minute

Electricity Use

**65**

Watts  
(excluding lights)

Airflow Efficiency

**107**

Cubic Feet Per  
Minute Per Watt



LIMITED LIFETIME MOTOR WARRANTY



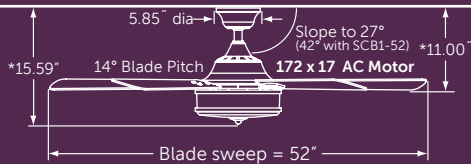

\*With included 4.5" downrod—longer lengths available  
Close-to-ceiling kit compatible

Net Hanging Weight: 23.2 lbs.

- 
**FAN: PL8274BN (1)**  
 brushed nickel assembly with  
 frosted white glass and reversible  
 cherry/dark walnut blades
  - dark walnut side showing



- 
**FAN: PL8274DZ (1)**  
 dark bronze assembly with  
 frosted white glass and reversible  
 cherry/dark walnut blades
  - cherry side showing



- 
**FAN: PL8274BN (1)**  
 brushed nickel assembly with  
 frosted white glass and reversible  
 cherry/dark walnut blades
  - cherry side showing



- 
**FAN: PL8274DZ (1)**  
 dark bronze assembly with  
 frosted white glass and reversible  
 cherry/dark walnut blades
  - dark walnut side showing



SOLD SEPARATELY:

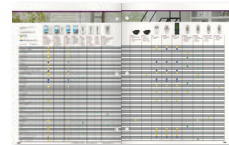

See page 141-146 for  
optional controls

# STAFFORD™

**FAN: PL8274DZ(1)**  
 dark bronze assembly with frosted white glass and reversible cherry/dark walnut blades  
 • dark walnut side showing

brushed nickel	dark bronze
cherry dark walnut	cherry dark walnut
<b>PL8274BN</b>	<b>PL8274DZ</b>

- FANSYNC™ compatible
- (3) 40W incandescent candelabra
- 3-SPEED AC reverse switch on fan
- CONTROL remote
- DRY indoor only

**INCLUDED:**



**ENERGY INFORMATION AT HIGH SPEED:**

Airflow	Electricity Use	Airflow Efficiency
<b>4911</b>	<b>56</b>	<b>88</b>
Cubic Feet Per Minute	Watts (excluding lights)	Cubic Feet Per Minute Per Watt

LIMITED LIFETIME MOTOR WARRANTY



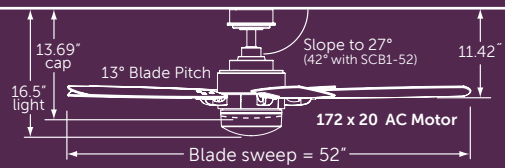

\*With included 4.5" downrod—longer lengths available  
Close-to-ceiling kit compatible

Net Hanging Weight: 19.6 lbs.

**FAN: FP8003BN (1)**  
brushed nickel assembly with opal frosted glass and reversible cherry/walnut wood blades  
● cherry side showing



**FAN: FP8003MW (1)**  
matte white assembly with opal frosted glass and matte white wood blades



**FAN: FP8003OB (1)**  
oil-rubbed bronze assembly with and reversible mahogany/walnut wood blades and matching light cover (included)  
● mahogany side showing



**FAN: FP8003PN (1)**  
polished nickel assembly with opal frosted glass and reversible cherry/walnut wood blades  
● cherry side showing



**FAN: FP8003SN (1)**  
satin nickel assembly with opal frosted glass and reversible cherry/walnut wood blades  
● walnut side showing



SOLD SEPARATELY:

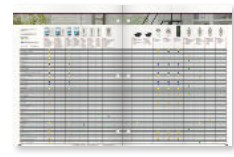

See page 141-146 for optional controls

# BENITO™

**FAN: FP8003BN** (1)  
brushed nickel assembly with  
opal frosted glass and reversible  
cherry/walnut wood blades  
• walnut side showing

brushed nickel	matte white	oil-rubbed bronze	polished nickel	satin nickel
cherry walnut	matte white	ma- hogany walnut	cherry walnut	cherry walnut
<b>FP8003BN</b>	<b>FP8003MW</b>	<b>FP8003OB</b>	<b>FP8003PN</b>	<b>FP8003SN</b>

  
FANSYNC™  
compatible

  
(1) 100W  
halogen  
minican

  
3-SPEED AC  
reverse switch  
on fan

  
CONTROL  
remote

  
DRY  
indoor only

## INCLUDED:



blade set



light kit  
light cover



TR24WH remote

## ENERGY INFORMATION AT HIGH SPEED:

Airflow  
**5052**  
Cubic Feet  
Per Minute

Electricity Use  
**63**  
Watts  
(excluding lights)

Airflow Efficiency  
**80**  
Cubic Feet Per  
Minute Per Watt



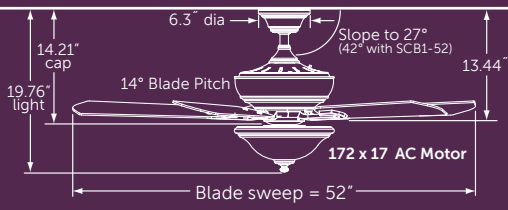

\*With included 4.5" downrod—longer lengths available  
Close-to-ceiling kit compatible

Net Hanging Weight: 24.47 lbs.

**FAN: FP8095BA (1)**  
bronze accent assembly with  
frosted white glass and reversible  
cherry/walnut wood blades  
● walnut side showing



**FAN: FP8095OB (1)**  
oil-rubbed bronze assembly (shown  
without light kit) with reversible  
cherry/walnut wood blades  
● cherry side showing



**FAN: FP8095PW (1)**  
pewter assembly with frosted  
white glass and reversible  
cherry/walnut wood blades  
● walnut side showing



**FAN: FP8095WH (1)**  
white assembly with white frosted  
glass and white wood blades



**SOLD SEPARATELY:**

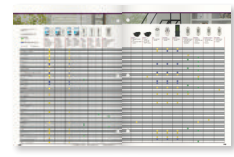

See page 141-146 for  
optional controls



# CAMHAVEN™

**FAN: FP8095PW(1)**  
 pewter assembly with frosted white glass and reversible cherry/walnut wood blades  
 • walnut side showing

bronze accent	oil-rubbed bronze	pewter	white
cherry walnut	cherry walnut	cherry walnut	white
<b>FP8095BA</b>	<b>FP8095OB</b>	<b>FP8095PW</b>	<b>FP8095WH</b>

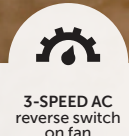

**INCLUDED:**



**ENERGY INFORMATION AT HIGH SPEED:**

Airflow	Electricity Use	Airflow Efficiency
<b>5813</b>	<b>67</b>	<b>87</b>
Cubic Feet Per Minute	Watts (excluding lights)	Cubic Feet Per Minute Per Watt

LIMITED LIFETIME MOTOR WARRANTY



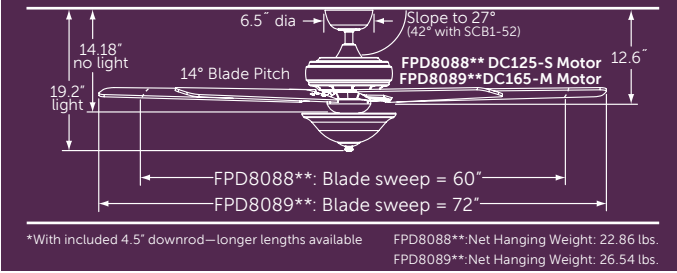

**FAN: FPD8088BA (1)**  
60" bronze accent assembly with amber linen glass and reversible cherry/walnut wood blades  
● cherry side showing



**FAN: FPD8088PW (1)**  
60" pewter assembly with reversible cherry/walnut wood blades. (shown without light kit)  
● walnut side showing



**FAN: FPD8089BA (1)**  
72" bronze accent assembly with reversible cherry/walnut wood blades. (shown without light kit)  
● walnut side showing



**FAN: FPD8089PW (1)**  
72" pewter assembly with white linen glass and reversible cherry/walnut wood blades  
● cherry side showing



**SOLD SEPARATELY:**

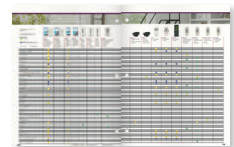

See page 141-146 for optional controls

# KEISTONE™

**FAN: FPD808089PW (1)**  
 72" pewter assembly with white  
 linen glass and reversible cherry/  
 walnut wood blades  
 • cherry side showing

bronze accent	pewter
cherry walnut FPD8088BA FPD8089BA	cherry walnut FPD8088PW FPD8089PW

INCLUDED:

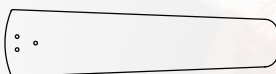

blade set



light kit



TR39 remote

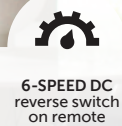

## ENERGY INFORMATION AT HIGH SPEED:

Airflow	6466
(FPD8088**)	8895
(FPD8089**)	
Cubic Feet Per Minute	

Electricity Use	30.2
Watts	29.3
(excluding lights)	

Airflow Efficiency	214
	304
Cubic Feet Per Minute Per Watt	

LIMITED LIFETIME MOTOR WARRANTY



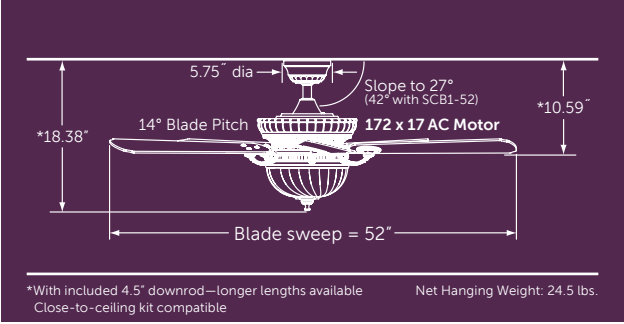

**FAN: FP8032DZ (1)**  
dark bronze assembly  
with frosted white glass  
and reversible cherry/dark  
walnut blades

- cherry side showing



**FAN: FP8032DZ (1)**  
dark bronze assembly  
with frosted white glass  
and reversible cherry/dark  
walnut blades

- dark walnut side showing

**SOLD SEPARATELY:**

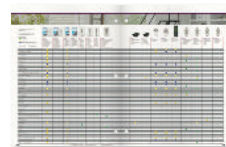

See page 141-146 for  
optional controls

# VENTANA™

**FAN: FP8032DZ (1)**  
 dark bronze assembly  
 with frosted white glass  
 and reversible cherry/dark  
 walnut blades  
 • dark walnut side showing

dark bronze  
 dark walnut  
 cherry  
**FP8032DZ**

  
**FANSYNC™**  
 compatible

  
 (2) 50W  
 halogen  
 minican

  
**3-SPEED AC**  
 reverse switch  
 on fan

  
**CONTROL**  
 remote

  
**DRY**  
 indoor only

**INCLUDED:**



blade set



light kit



TR24WH remote

**ENERGY INFORMATION  
 AT HIGH SPEED:**

Airflow  
**5792**  
 Cubic Feet  
 Per Minute

Electricity Use  
**83**  
 Watts  
 (excluding lights)

Airflow Efficiency  
**70**  
 Cubic Feet Per  
 Minute Per Watt

**LIMITED LIFETIME MOTOR WARRANTY**



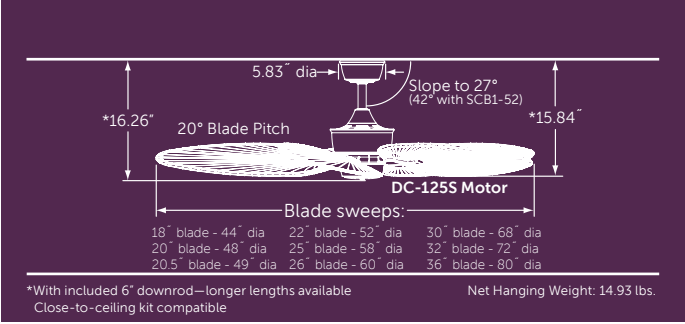

**FAN: MAD3255BA** (1)  
bronze accent assembly  
**BLADES: ISP1** (1)  
52" sweep natural palm  
leaf wide oval



**FAN: MAD3255PW** (1)  
pewter assembly  
**BLADES: ISD4A** (1)  
52" sweep antique narrow  
oval woven bamboo



**SOLD SEPARATELY:**



blade options: p.149-150  
control options: p.141-146  
light options: p.139-140

# LOUVRE™



**FAN: MAD3255PW** (1)  
pewter assembly  
**BLADE SET: B5133TKMH** (1)  
52" sweep reversible teak/  
mahogany wood  
• teak side showing

bronze accent  
**MAD3255BA** pewter  
**MAD3255PW**

- ENERGY SAVINGS
- MIX & MATCH components sold separately
- 6-SPEED DC reverse switch on remote
- CONTROL remote
- DRY indoor only

INCLUDED:



TR39 remote

### ENERGY INFORMATION AT HIGH SPEED:

Airflow measured with B5330\*\* blade

Airflow	Electricity Use	Airflow Efficiency
<b>5412</b>	<b>30</b>	<b>183</b>
Cubic Feet Per Minute	Watts (excluding lights)	Cubic Feet Per Minute Per Watt



LIMITED LIFETIME MOTOR WARRANTY



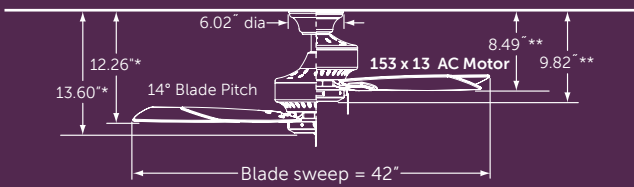

\*With included 4.5" downrod—longer lengths available  
 \*\*With included flush mount kit

Net Hanging Weight: 15.37 lbs.



**FAN: FP8042OB (1)**  
 oil-rubbed bronze assembly in flush-mount configuration with reversible cherry/walnut wood blades  
 ● cherry side showing

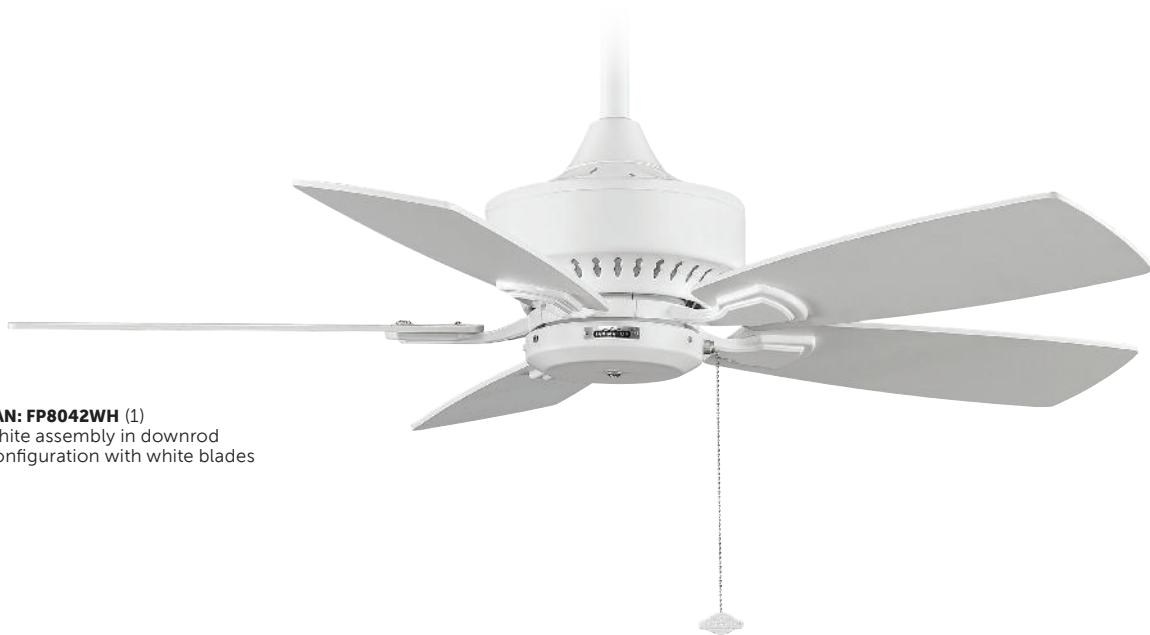

**FAN: FP8042WH (1)**  
 white assembly in downrod configuration with white blades

**SOLD SEPARATELY:**

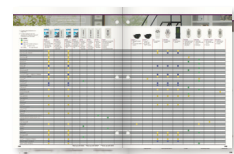





control options: p.141-146  
 light options: p.139-140



# CANCUN™ 42

- FAN: FP8042OB (1)**  
oil-rubbed bronze assembly with reversible cherry/walnut wood blades
- walnut side showing

oil-rubbed bronze	white
cherry walnut	white
<b>FP8042OB</b>	<b>FP8042WH</b>

 <b>FANSYNC™</b> compatible	 <b>3-SPEED AC</b> reverse switch on fan	 <b>CONTROL</b> pull chain	 <b>DRY</b> indoor only
---	--	---	--

**INCLUDED:**



blade set

**ENERGY INFORMATION  
AT HIGH SPEED:**

Airflow	Electricity Use	Airflow Efficiency
<b>3943</b>	<b>47</b>	<b>84</b>
Cubic Feet Per Minute	Watts (excluding lights)	Cubic Feet Per Minute Per Watt

**LIMITED LIFETIME MOTOR WARRANTY**



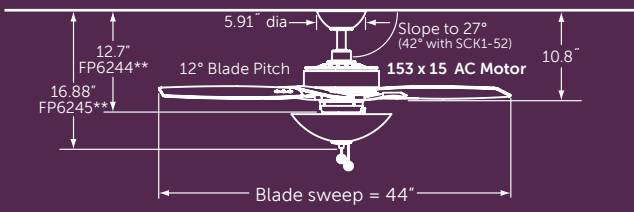

\*With included 4.5" downrod—longer lengths available

FP6244\*\* Net Hanging Weight: 14.66 lbs.  
FP6245\*\* Net Hanging Weight: 16.64 lbs.



- FAN: FP6244BN (1)**  
brushed nickel assembly  
with reversible cherry/dark  
walnut wood blades  
● dark walnut side showing



- FAN: FP6244DZ (1)**  
dark bronze assembly with reversible  
cherry/dark walnut wood blades  
● cherry side showing



- FAN: FP6244MW (1)**  
matte white assembly with  
matte white wood blades



**SOLD SEPARATELY:**

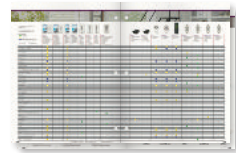

control options: p.141-146  
light options: p.139-140

# AIRE DELUXE™ 44



**FAN: FP6245BN** (1)  
brushed nickel assembly  
with white frosted glass  
bowl and reversible cherry/  
dark walnut blades

- dark walnut side showing



**FAN: FP6245DZ** (1)  
dark bronze assembly with  
white frosted glass bowl  
and reversible cherry/dark  
walnut blades

- cherry side showing



**FAN: FP6245MW** (1)  
matte white assembly with  
white frosted glass bowl and  
matte white blades

brushed nickel	dark bronze	matte white
cherry dark walnut	cherry dark walnut	matte white
<b>FP6244BN</b> <b>FP6245BN</b>	<b>FP6244DZ</b> <b>FP6245DZ</b>	<b>FP6244MW</b> <b>FP6245MW</b>

INCLUDED:



blade set



light kit—FP6245\*\* only

FANSYNC™ compatible	(3) 13W GU24 CFL FP6245** only	3-SPEED AC reverse switch on fan	CONTROL pull chain	DRY indoor only

## ENERGY INFORMATION AT HIGH SPEED:

	Airflow	Electricity Use	Airflow Efficiency
FP6244**	<b>3905</b>	<b>53</b>	<b>74</b>
FP6245**	<b>3937</b>	<b>53</b>	<b>75</b>
	Cubic Feet Per Minute	Watts (excluding lights)	Cubic Feet Per Minute Per Watt



LIMITED LIFETIME MOTOR WARRANTY



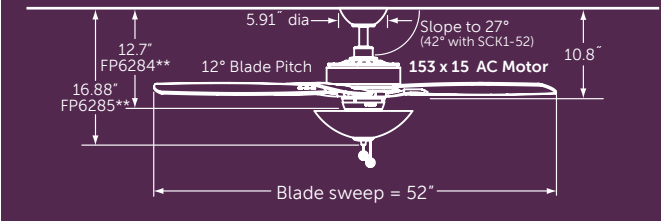

\*With included 4.5" downrod—longer lengths available  
 FP6284\*\* Net Hanging Weight: 15.36 lbs.  
 FP6285\*\* Net Hanging Weight: 17.34 lbs.



**FAN: FP6284BN (1)**  
 brushed nickel assembly  
 with reversible cherry/dark  
 walnut wood blades  
 ● dark walnut side showing



**FAN: FP6284DZ (1)**  
 dark bronze assembly with reversible  
 cherry/dark walnut wood blades  
 ● cherry side showing



**FAN: FP6284MW (1)**  
 matte white assembly with  
 matte white wood blades



**SOLD SEPARATELY:**

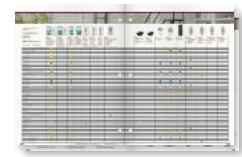

control options: p.141-146  
 light options: p.139-140

# AIRE DELUXE™ 52



**FAN: FP6285BN (1)**  
brushed nickel assembly with white frosted glass bowl and reversible cherry/dark walnut blades

- dark cherry side showing



**FAN: FP6285DZ (1)**  
dark bronze assembly with white frosted glass bowl and reversible cherry/dark walnut blades

- dark walnut side showing



**FAN: FP6285MW (1)**  
matte white assembly with white frosted glass bowl and matte white blades

brushed nickel	dark bronze	matte white
cherry dark walnut	cherry dark walnut	matte white
<b>FP6284BN</b> <b>FP6285BN</b>	<b>FP6284DZ</b> <b>FP6285DZ</b>	<b>FP6284MW</b> <b>FP6285MW</b>

INCLUDED:



blade set

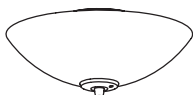

light kit—FP6285\*\* only

FANSYNC™ compatible	(3) 13W GU24 CFL FP6285** only	3-SPEED AC reverse switch on fan	CONTROL pull chain	DRY indoor only

## ENERGY INFORMATION AT HIGH SPEED:

Airflow	Electricity Use	Airflow Efficiency
FP6284** <b>5284</b>	<b>54</b>	<b>97</b>
FP6285** <b>5279</b>	<b>54</b>	<b>97</b>
Cubic Feet Per Minute	Watts (excluding lights)	Cubic Feet Per Minute Per Watt



LIMITED LIFETIME MOTOR WARRANTY



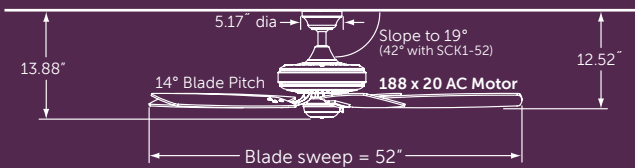

\*With included 4.5" downrod—longer lengths available  
Close-to-ceiling kit compatible

Net Hanging Weight: 21.19 lbs.



- FAN: TF610OB (1)**  
oil-rubbed bronze assembly with reversible cherry/walnut wood blades  
● walnut side showing



- FAN: TF610SN (1)**  
satin nickel assembly with reversible walnut/light walnut wood blades  
● walnut side showing



- FAN: TF610WH (1)**  
white assembly with reversible white/white oak wood blades  
● white side showing



**SOLD SEPARATELY:**

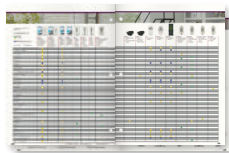

control options: p.141-146  
light options: p.139-140



reversible 42" sweep  
walnut/light walnut

**BEW42WALW**  
wood

# EDGEWOOD® DECORATIVE



**FAN: TF610SN (1)**  
oil-rubbed bronze assembly with reversible cherry/walnut wood blades  
• walnut side showing

oil-rubbed bronze	satin nickel	white
cherry walnut	light walnut	white oak
<b>TF610OB</b>	<b>TF610SN</b>	<b>TF610WH</b>



INCLUDED:



blade set

ENERGY INFORMATION AT HIGH SPEED:

Airflow  
**7057**  
Cubic Feet Per Minute

Electricity Use  
**80**  
Watts (excluding lights)

Airflow Efficiency  
**89**  
Cubic Feet Per Minute Per Watt



LIMITED LIFETIME MOTOR WARRANTY



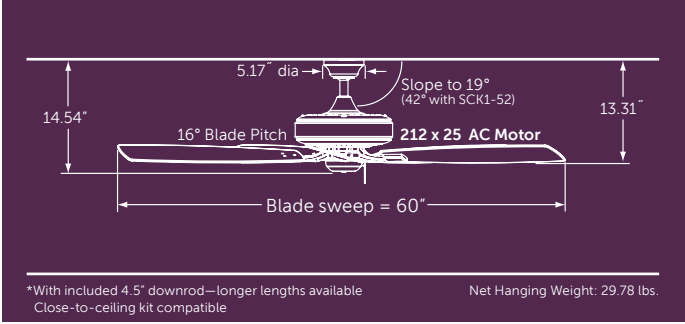

**FAN: TF710OB (1)**  
oil-rubbed bronze  
assembly with reversible  
cherry/walnut wood blades  
● walnut side showing



**FAN: TF710SN (1)**  
satin nickel assembly with  
reversible walnut/light  
walnut wood blades  
● light walnut side showing



**FAN: TF710WH (1)**  
white assembly with  
reversible white/white  
oak wood blades  
● white oak side showing



**SOLD SEPARATELY:**

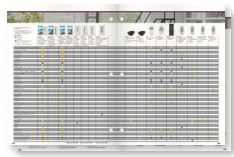

control options: p.141-146  
light options: p.139-140



reversible 42" sweep  
walnut/light walnut

**BEW42WALW**  
wood



# EDGEWOOD® DELUXE



**FAN: TF710OB (1)**  
oil-rubbed bronze assembly  
with reversible cherry/  
walnut wood blades  
• walnut side showing

oil-rubbed bronze	satin nickel	white
cherry walnut	light walnut	white oak
<b>TF710OB</b>	<b>TF710SN</b>	<b>TF710WH</b>

INCLUDED:



blade set

ENERGY INFORMATION  
AT HIGH SPEED:

			
FANSYNC™ compatible	3-SPEED AC reverse switch on fan	CONTROL pull chain	DRY indoor only

Airflow	Electricity Use	Airflow Efficiency
<b>8963</b>	<b>84</b>	<b>106</b>
Cubic Feet Per Minute	Watts (excluding lights)	Cubic Feet Per Minute Per Watt



LIMITED LIFETIME MOTOR WARRANTY



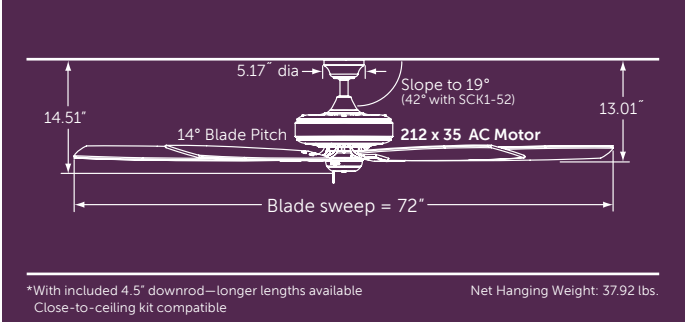

**FAN: TF721OB (1)**  
oil-rubbed bronze assembly with reversible cherry/walnut wood blades  
● cherry side showing



**FAN: TF721WH (1)**  
white assembly with reversible white/white oak wood blades  
● white side showing

**SOLD SEPARATELY:**



control options: p.141-146  
light options: p.139-140

# EDGEWOOD® SUPREME



**FAN: TF721OB** (1)  
oil-rubbed bronze  
assembly with  
reversible cherry/  
walnut wood blades  
● walnut side showing

oil-rubbed  
bronze

cherry walnut

**TF721OB**

white

white oak

**TF721WH**

INCLUDED:



blade set

ENERGY INFORMATION  
AT HIGH SPEED:

  
FANSYNC™  
compatible

Airflow  
**9689**  
Cubic Feet  
Per Minute

  
3-SPEED AC  
reverse switch  
on fan

Electricity Use  
**90**  
Watts  
(excluding lights)

  
CONTROL  
pull chain

Airflow Efficiency  
**107**  
Cubic Feet Per  
Minute Per Watt

  
DRY  
indoor only



LIMITED LIFETIME MOTOR WARRANTY



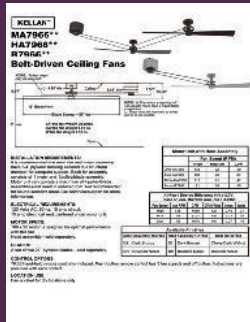

For dimensions and configurations, please see our comprehensive Specification Book or model-specific specification sheet, available at [fanimation.com](http://fanimation.com)

Not recommended for use in sound sensitive areas.

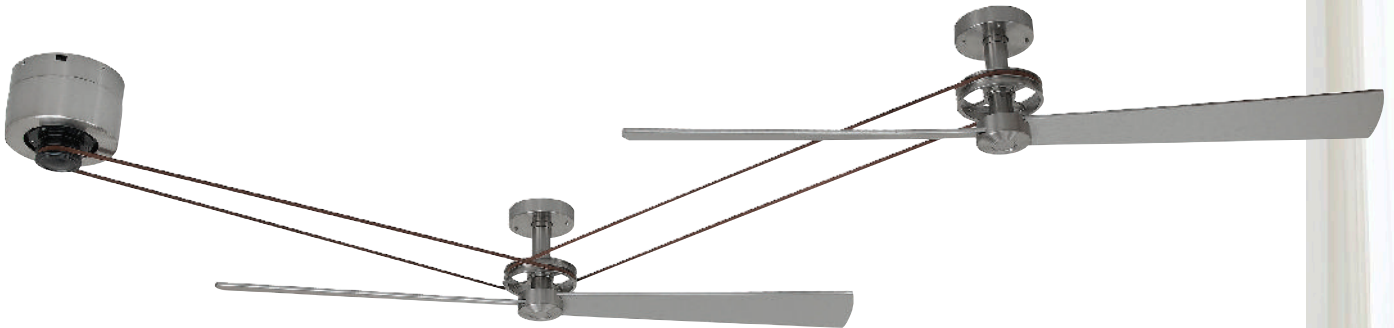

- ◆ **MOTOR: MA7966BN** (1)  
brushed nickel
- ◆ **HEAD: HA7966BN** (2)  
brushed nickel assembly
- ◆ **BLADE SET: B7966BN** (2)  
brushed nickel

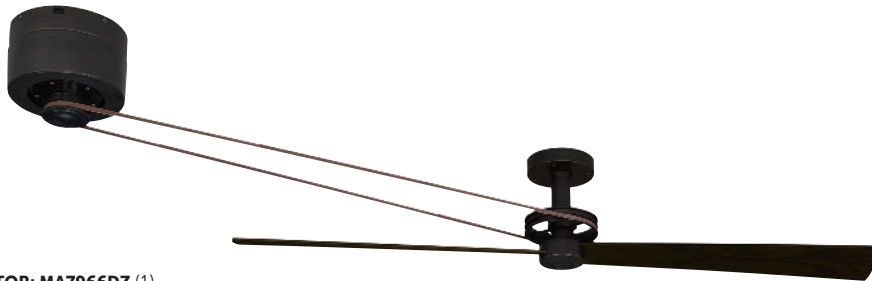

- ◆ **MOTOR: MA7966DZ** (1)  
dark bronze
- ◆ **HEAD: HA7966DZ** (1)  
dark bronze assembly
- ◆ **BLADE SET: B7966CYDWA** (1)  
reversible cherry/dark walnut
- dark walnut side showing

**SOLD SEPARATELY:**

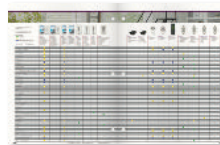

See page 141-146 for optional controls



BN—brushed nickel

CYDWA—cherry/dark walnut reversible

**B7966\*\***  
wood



# KELLAN™

- ◆ **MOTOR: MA7966BN** (1)  
brushed nickel
- ◆ **HEAD: HA7966BN** (1)  
brushed nickel assembly
- ◆ **BLADE SET: B7966BN** (1)  
brushed nickel

brushed  
nickel  
**MA7966BN**  
**HA7966BN**

dark  
bronze  
**MA7966DZ**  
**HA7966DZ**

  
**MIX & MATCH**  
components  
sold separately

  
**3-SPEED AC**  
reverse switch  
on remote

  
**CONTROL**  
remote

  
**DRY**  
indoor only

INCLUDED:



TR33 control

ENERGY INFORMATION  
AT HIGH SPEED:

Airflow  
**4659**  
Cubic Feet  
Per Minute

Electricity Use  
**37**  
Watts  
(excluding lights)

Airflow Efficiency  
**128**  
Cubic Feet Per  
Minute Per Watt

LIMITED LIFETIME MOTOR WARRANTY



Due to their complex systems, multiple components and special installation requirements, we recommend contacting our Customer Service department for assistance with ordering—888.567.2055

For dimensions and configurations, please see our comprehensive Specification Book or model-specific specification sheet, available at [www.fanimation.com](http://www.fanimation.com)

BOURBON STREET®



- ◆ **MOTOR: FP580BL** (1)  
black (required but not shown)
- ◆ **HEAD: FP510BL** (3)  
black short assembly
- ◆ **BLADES: FP1018** (3)  
52" sweep reversible oak/walnut wood
- oak side showing

PALMETTO®

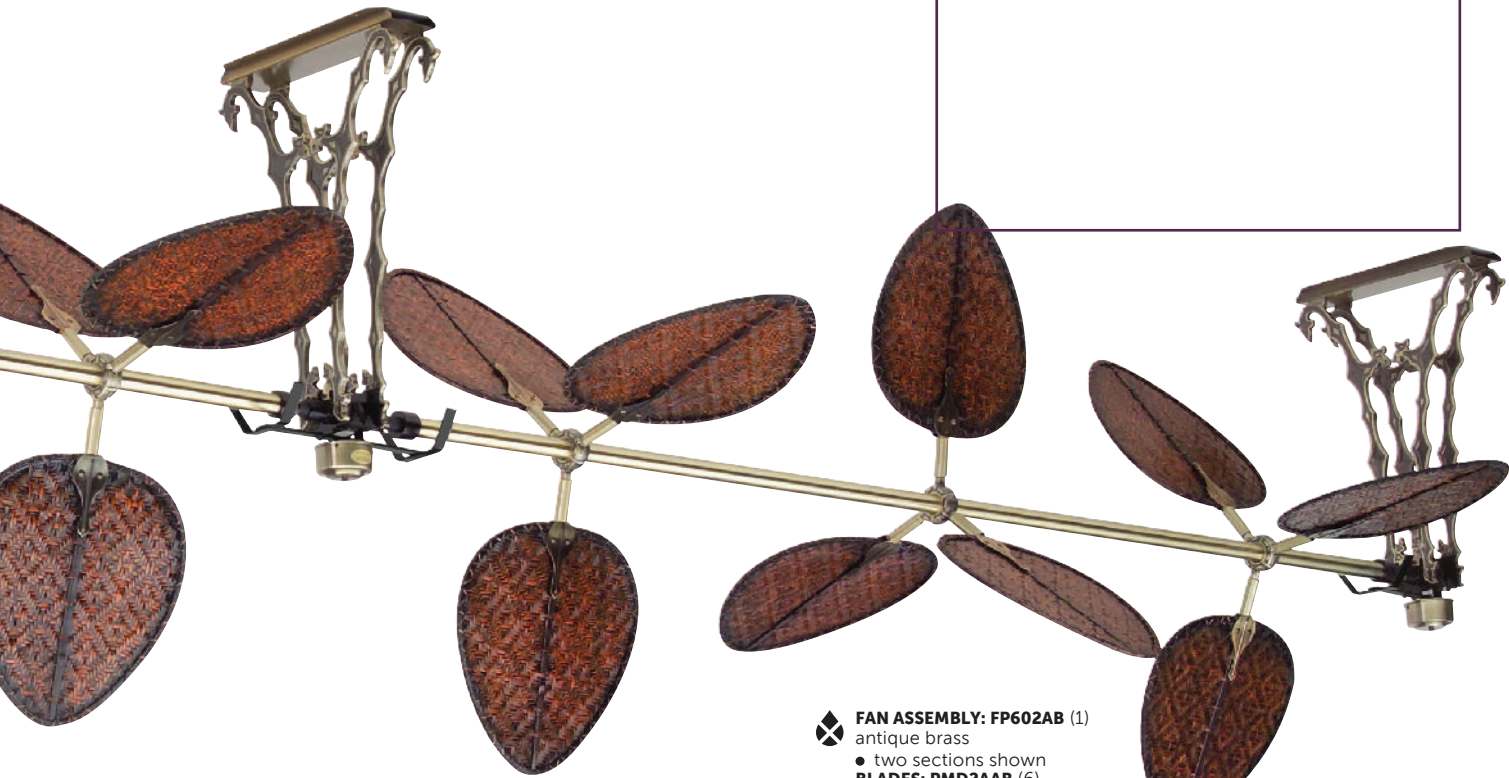

◆ **FAN ASSEMBLY: FP602AB** (1)  
antique brass  
● two sections shown  
**BLADES: PMD2AAB** (6)  
antique brass assemblies  
with antique woven  
bamboo wide oval blades









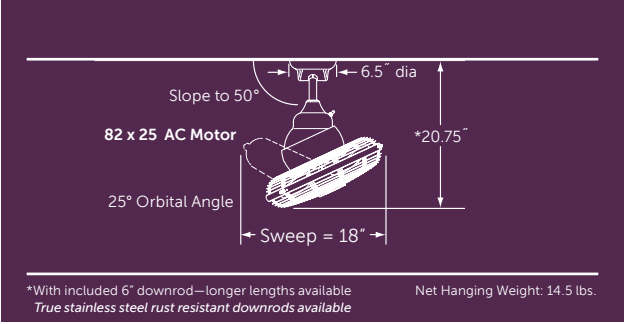

INDOOR/OUTDOOR



 **FAN: OF110BL (1)**  
black assembly with black cage



 **FAN: OF110OB (1)**  
oil-rubbed bronze assembly with black cage



 **FAN: OF110PW (1)**  
pewter assembly with black cage



 **FAN: OF110SN (1)**  
satin nickel assembly with black cage



**SOLD SEPARATELY:**

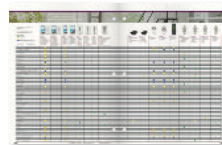

See page 141-146 for optional controls

# EXTRAORDINAIRE™



 **FAN: OF110OB** (1)  
oil-rubbed bronze  
assembly with black cage

black	oil-rubbed bronze	pewter	satin nickel
black	black	black	black
<b>OF110BL</b>	<b>OF110OB</b>	<b>OF110PW</b>	<b>OF110SN</b>

INCLUDED:



CW110WH wall control

## ENERGY INFORMATION AT HIGH SPEED:

Airflow	Electricity Use	Airflow Efficiency
<b>847</b>	<b>85</b>	<b>10</b>
Cubic Feet Per Minute	Watts (excluding lights)	Cubic Feet Per Minute Per Watt



**3-SPEED AC**  
no reverse



**CONTROL**  
wall



**DRY OR DAMP**  
model specific

LIMITED LIFETIME MOTOR WARRANTY



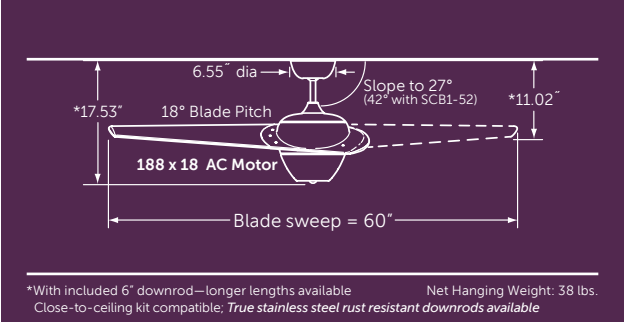

 **FAN: FP2120MG (1)**  
 metro gray assembly  
 (shown with light cap-included)



 **FAN: FP2120MG (1)**  
 metro gray assembly  
 (shown with light cap-included)



**SOLD SEPARATELY:**

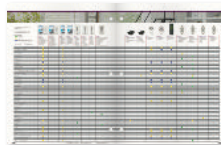

See page 141-146 for optional controls

# ENIGMA™



**FAN: FP2120MG (1)**  
metro gray assembly  
(shown with light cap-included)

metro gray  
metro gray  
metro gray  
**FP2120MG**

- FANSYNC™** compatible
- 11W** E26 LED
- 3-SPEED AC** no reverse
- CONTROL** remote
- DAMP** indoor/outdoor

**INCLUDED:**

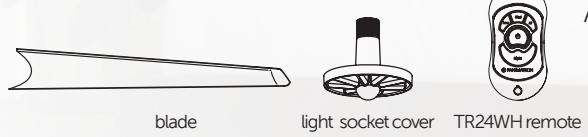

**ENERGY INFORMATION AT HIGH SPEED:**

Airflow	Electricity Use	Airflow Efficiency
<b>5796</b>	<b>51</b>	<b>114</b>
Cubic Feet Per Minute	Watts (excluding lights)	Cubic Feet Per Minute Per Watt

**LIMITED LIFETIME MOTOR WARRANTY**



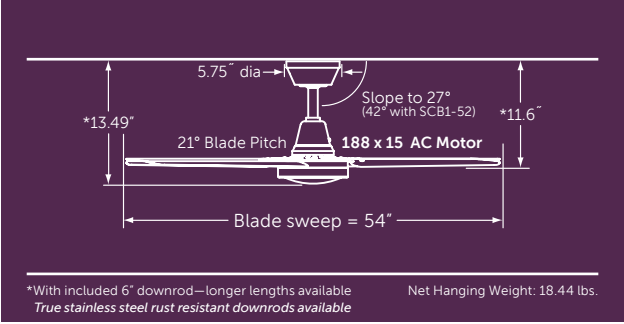

NOTE: DISTANCE FROM FLOOR TO BLADES MUST BE AT LEAST 10 FEET FOR THE ASCENSION™



**FAN: FP6717BN (1)**  
 brushed nickel assembly with  
 brushed nickel blades



**FAN: FP6717MW (1)**  
 matte white assembly with matte  
 white blades



SOLD SEPARATELY:

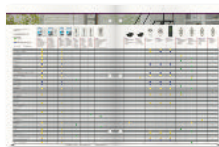

See page 141-146 for  
 optional controls

# ASCENSION™



**FAN: FP6717BN (1)**  
brushed nickel assembly with  
brushed nickel blades



brushed  
nickel  
brushed  
nickel  
**FP6717BN**

matte  
white  
matte  
white  
**FP6717MW**

INCLUDED:

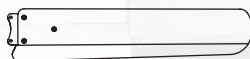

blade set



CW6717WH wall control



FANSYNC™  
compatible



3-SPEED AC  
reverse switch  
on fan



CONTROL  
wall



DAMP  
indoor/outdoor

## ENERGY INFORMATION AT HIGH SPEED:

Airflow  
**6659**  
Cubic Feet  
Per Minute

Electricity Use  
**53**  
Watts  
(excluding lights)

Airflow Efficiency  
**127**  
Cubic Feet Per  
Minute Per Watt



LIMITED LIFETIME MOTOR WARRANTY



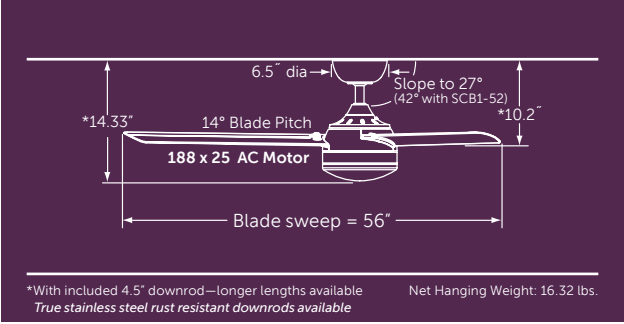

**FAN: FP6728BN (1)**  
brushed nickel assembly with  
opal frosted glass and brushed  
nickel blades



**FAN: FP6728DZ (1)**  
dark bronze assembly with opal  
frosted glass and dark walnut  
blades

**SOLD SEPARATELY:**

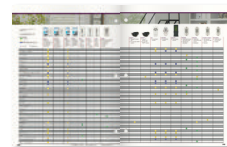

See page 141-146 for  
optional controls



# XENO™



**FAN: FP6728BN (1)**  
brushed nickel assembly with opal frosted glass and dark walnut blades

brushed nickel  
brushed nickel  
**FP6728BN**

dark bronze  
dark walnut  
**FP6728DZ**

**INCLUDED:**

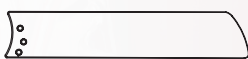

blade set



light kit



BTT9

**ENERGY INFORMATION AT HIGH SPEED:**

Airflow  
**7236**  
Cubic Feet Per Minute

Electricity Use  
**66**  
Watts (excluding lights)

Airflow Efficiency  
**110**  
Cubic Feet Per Minute Per Watt

**FANSYNC™** included

**18W LED**

**3-SPEED AC** reverse switch on fan

**CONTROL** remote

**DAMP** indoor/outdoor



**LIMITED LIFETIME MOTOR WARRANTY**



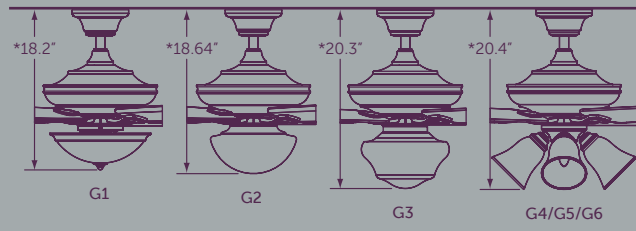
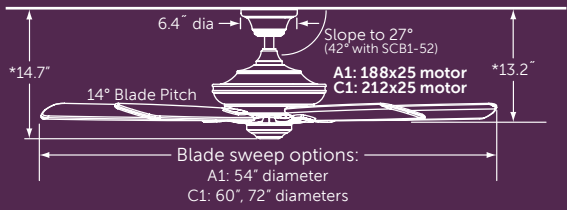

\*With included 6" downrod—longer lengths available  
 True stainless steel rust resistant downrods available  
 A1 Net Hanging Weight: 23.53 lbs.  
 C1 Net Hanging Weight: 26.63 lbs.



**FAN: A1DZ (1)**  
 dark bronze assembly  
**BLADES: B754DWA (1)**  
 54" sweep dark walnut



**FAN: C1BN (1)**  
 brushed nickel assembly  
**BLADES: B172DWA (1)**  
 72" sweep dark walnut  
**LIGHT FITTER: F2BN (1)**  
 brushed nickel globe fitter  
**GLASS: G3CL (1)**  
 clear schoolhouse glass globe  
 • shown with optional vintage bulb



**FAN: A1MW (1)**  
 matte white assembly  
**BLADES: B254MW (1)**  
 54" sweep matte white



**FAN: C1DZ (1)**  
 dark bronze assembly  
**BLADES: B560DWA (1)**  
 60" sweep dark walnut  
**LIGHT FITTER: F3DZ (1)**  
 dark bronze LED bowl fitter  
**GLASS: G1MS (1)**  
 marble swirl glass bowl



**FAN: C1MW (1)**  
 matte white assembly  
**BLADES: B460CY (1)**  
 60" sweep cherry  
**LIGHT FITTER: F4MW (1)**  
 matte white 4 light fitter  
**GLASS: G5OP (4)**  
 2 1/4" opal frosted



**SOLD SEPARATELY:**









See inside fold for blades, fitters, glass & controls

My **FANIMATION**  
**DISTINCTION™ DC**



-  **FAN: D1BN** (1)  
brushed nickel assembly
- BLADES: B172DWA** (1)  
72" sweep dark walnut
- LIGHT FITTER: F2BN** (1)  
brushed nickel globe fitter
- GLASS: G3CL** (1)  
clear schoolhouse glass globe
- shown with optional vintage bulb

- brushed nickel  
**D1BN**
- dark bronze  
**D1DZ**
- matte white  
**D1MW**

-  **ENERGY SAVINGS**
-  **MIX & MATCH**  
components sold separately
-  **FANsync™**  
included
-  **31-SPEED DC**  
reverse switch on remote
-  **CONTROL**  
remote
-  **DAMP**  
indoor/outdoor

INCLUDED:   
  
 TR205 control

**ENERGY INFORMATION AT HIGH SPEED:**

Airflow	Electricity Use	Airflow Efficiency
<b>8800</b>	<b>32</b>	<b>275</b>
Cubic Feet Per Minute	Watts (excluding lights)	Cubic Feet Per Minute Per Watt



**LIMITED LIFETIME MOTOR WARRANTY**



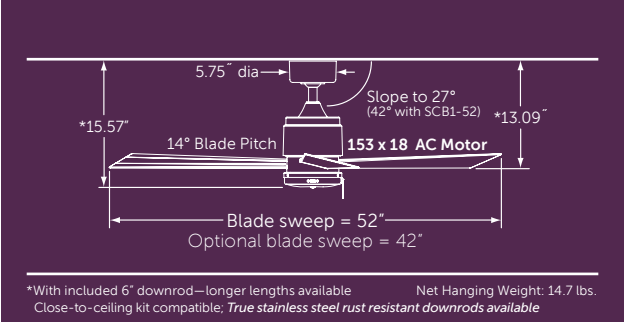

**FAN: FP4640OB (1)**  
oil-rubbed bronze assembly with  
cherry all weather composite blades

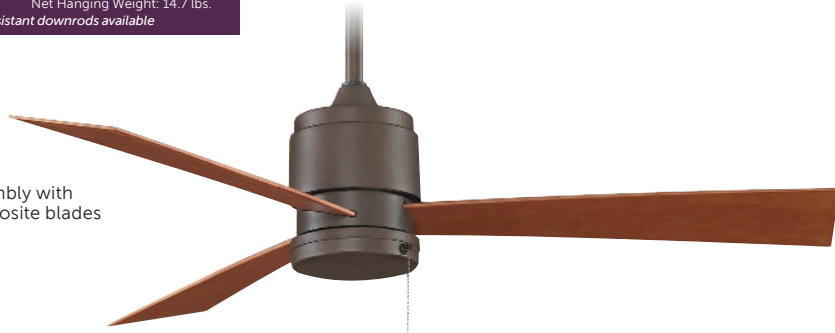

**FAN: FP4640SN (1)**  
satin nickel assembly with satin  
nickel all weather composite blades



**FAN: FP4640WH (1)**  
white assembly with white all  
weather composite blades



**FAN: FP4640OB (1)**  
oil-rubbed bronze  
assembly with cherry all  
weather composite blades  
**LIGHT KIT: LK4640OB (1)**  
oil-rubbed bronze finish  
18W LED light kit



**SOLD SEPARATELY:**

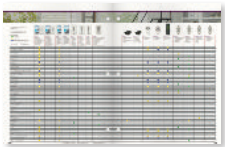

See page 141-146 for  
additional control options



**BPW4426\*\***  
composite



**LK4640\*\***  
18W LED

use with  
CW60WH



**CW60WH**  
wall control

must be  
paired  
with WP60  
for outdoor  
application



**WP60**  
waterproof box

*My* FANIMATION  
 DISTINCTION™ AC

**FAN: A1MW** (1)  
 matte white assembly  
**BLADES: B654MW** (1)  
 54" sweep matte white  
**LIGHT FITTER: F2MW** (1)  
 matte white globe fitter  
**GLASS: G2OP** (1)  
 opal frosted glass globe

brushed  
 nickel  
**A1BN**  
**C1BN**

dark  
 bronze  
**A1DZ**  
**C1DZ**

matte  
 white  
**A1MW**  
**C1MW**

  
**FANSync™**  
 included

  
**3-SPEED AC**  
 reverse switch  
 on fan

  
**CONTROL**  
 remote

  
**DAMP**  
 indoor/outdoor

INCLUDED: 



BTT9

ENERGY INFORMATION  
 AT HIGH SPEED:

	Airflow	Electricity Use	Airflow Efficiency
A1**	<b>5849</b>	<b>77</b>	<b>76</b>
C1**	<b>8900</b>	<b>89</b>	<b>100</b>
	Cubic Feet Per Minute	Watts (excluding lights)	Cubic Feet Per Minute Per Watt



LIMITED LIFETIME MOTOR WARRANTY



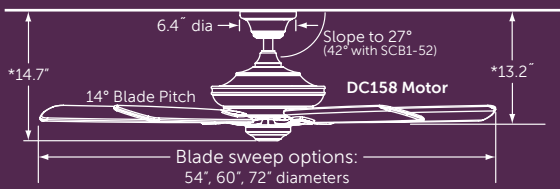

\*With included 6" downrod—longer lengths available  
 True stainless steel rust resistant downrods available  
 Net Hanging Weight: 17.57 lbs.

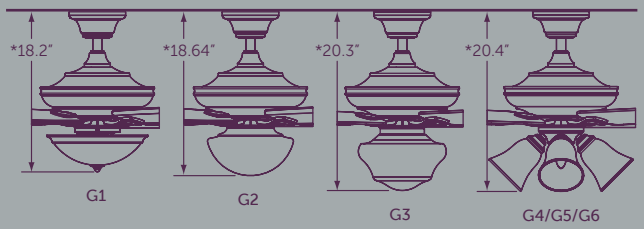

**FAN: D1DZ** (1)  
 dark bronze assembly  
**BLADES: B360CY** (1)  
 60" sweep cherry



**FAN: D1BN** (1)  
 brushed nickel assembly  
**BLADES: B260DWA** (1)  
 60" sweep dark walnut  
**LIGHT FITTER: F4BN** (1)  
 brushed nickel 4 light fitter  
**GLASS: G4OPS** (4)  
 2 3/4" opal frosted shiny



**FAN: D1MW** (1)  
 matte white assembly  
**BLADES: B654MW** (1)  
 54" sweep matte white  
**LIGHT FITTER: F2MW** (1)  
 matte white globe fitter  
**GLASS: G2OP** (1)  
 opal frosted glass globe



**FAN: D1DZ** (1)  
 dark bronze assembly  
**BLADES: B154CY** (1)  
 54" sweep cherry  
**LIGHT FITTER: F1DZ** (1)  
 dark bronze bowl fitter  
**GLASS: G1TST** (1)  
 tea stain glass bowl



**FAN: D1BN** (1)  
 brushed nickel assembly  
**BLADES: B860MW** (1)  
 60" sweep matte white



**SOLD SEPARATELY:**



See inside fold for blades,  
 fitters, glass & controls

my FANIMATION  
DISTINCTION™

40+ YEARS OF DESIGNING AND  
ENGINEERING CEILING FANS



Tom Frampton, Founder and CEO of Fanimation knows ceiling fans. While a junior in high school, Tom went to work for a fan design and manufacturing company, gaining experience in most departments and learning every facet of the business. Fast forward over forty years and enter the myFanimation™ collection. Distinction, the first introduction under the collection, is defined by its clean design and advanced technology. The myFanimation™ collection is a culmination of his life's commitment to transforming the ceiling fan as we know it.

Two hanger balls: \_\_\_\_\_

- Standard—slope to 19°
- Offset—slope to 32°

Tri-mount system: \_\_\_\_\_

- Downrod straight
- Downrod slope
- Motor-to-canopy snugger

Outer canopy trim \_\_\_\_\_  
ring hides screws



DAMP  
indoor/outdoor  
(including blades  
and accessories)

Fan Shield™: \_\_\_\_\_

- Rubber grommets attach to the hub\*
- The isolation ring system prevents noise and vibration from traveling from the motor through the blade holders and blades
- System is fail-safe and serviceable

No unsightly center screw \_\_\_\_\_

\*Utility patent pending



myFanimation fans include fanSync™ smart device controls

AC: 3-SPEED INFINITE LIGHT FAN DIRECTION FAN TIMER SAFE EXIT  
AC control via fanSync app only AC control via fanSync app only

DC: 31-SPEED INFINITE LIGHT FAN DIRECTION FAN TIMER FRESH AIR  
 HOME AWAY SAFE EXIT

**Unique features**

<b>FAN TIMER</b>	Sets timer for fan & light to turn off (max 6 hours)	<b>HOME AWAY</b>	Light turns on and off at set intervals to simulate someone being home.
<b>FRESH AIR</b>	Variable fan speeds simulate a natural breeze.	<b>SAFE EXIT</b>	Fan & light will turn off after one minute to allow for safe exit

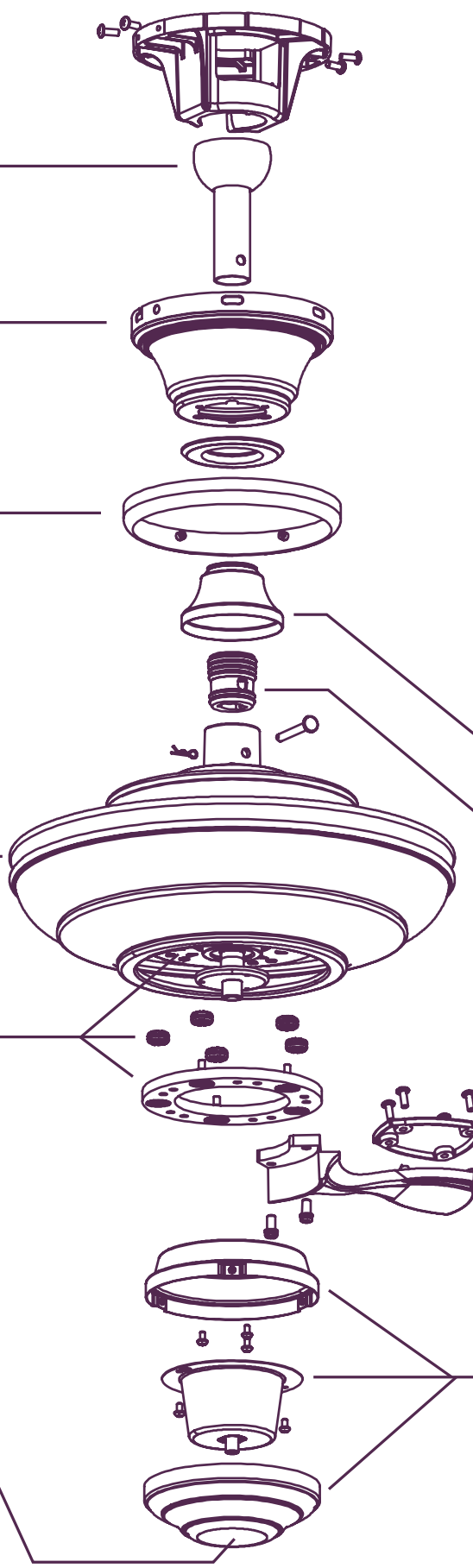

Decorative cover hides top support

**Hang Right™:**

- Rubber boot mounts in-between the down rod and top support\*
- The downrod mounts perfectly straight and snug in the top support and does not offset or sit at angle from securing old style set screws
- No top support sets screws to loosen and vibrate
- The downrods mount faster onto the motor and without tools
- Less motor vibration travelling up the downrod and into the ceiling

Recessed screw holes in blade holder top piece hide screws from visibility

Switch cup cover hides screws



## SIMPLE PART NUMBERING SYSTEM:

1. Motor: **A, C or D**

Example: **A1BN**

myFanimation motor finish code

2. Blades: **B**

Example: **B160WA**

myFanimation blade finish blade style sweep code

3. Fitter: **F**

Example: **F1DZ**

myFanimation fitter style finish code

4. Glass: **G**

Example: **G2CL**

myFanimation finish glass style code

### 1. Motors



**A1 (188 x 25)**

**BN | DZ | MW**

#### ENERGY INFORMATION

at High Speed\*

Airflow	Electricity Use	Airflow Efficiency
<b>5,849</b>	<b>77</b>	<b>76</b>
Cubic Feet Per Minute	Watts (excluding lights)	Cubic Feet Per Minute Per Watt

\*tested using B154 blade set

Order with 54" sweep blade sets only



**C1 (212 x 25)**

**BN | DZ | MW**

#### ENERGY INFORMATION

at High Speed\*

Airflow	Electricity Use	Airflow Efficiency
<b>8,900</b>	<b>89</b>	<b>100</b>
Cubic Feet Per Minute	Watts (excluding lights)	Cubic Feet Per Minute Per Watt

\*tested using B172 blade set

Order with 60" or 72" sweep blade sets only



**D1 (DC158)**

**BN | DZ | MW**

#### ENERGY INFORMATION

at High Speed\*

Airflow	Electricity Use	Airflow Efficiency
<b>8,800</b>	<b>32</b>	<b>275</b>
Cubic Feet Per Minute	Watts (excluding lights)	Cubic Feet Per Minute Per Watt

\*tested using B172 blade set

Order with 54", 60" or 72" sweep blade sets

### Finish Codes

#### Motors:

BN brushed nickel  
DZ dark bronze  
MW matte white

#### Blades:

CY cherry  
CYN cherry with natural inlay  
DC dark cherry  
DWA dark walnut  
MW matte white  
WA walnut  
WADWA walnut with dark walnut inlay  
WE weathered wood

#### Light Kits:

BN brushed nickel  
DZ dark bronze  
MW matte white

#### Glass:

CL clear  
FW frosted white  
MS marble swirl  
OP opal frosted  
OPS opal frosted shiny  
TST tea stained

### 2. Blades



	B1			B2			B3			B4			B5		B6		B7		B8	
	54"	60"	72"	54"	60"	72"	54"	60"	72"	54"	60"	72"	54"	60"	54"	60"	54"	60"	54"	60"
CY	☐	☐	☐	☐	☐	☐	☐	☐	☐											
CYN										☐	☐	☐								
DC																			☐	☐
DWA	☐	☐	☐	☐	☐	☐	☐	☐	☐				☐	☐	☐	☐	☐	☐		
MW	☐	☐	☐	☐	☐	☐	☐	☐	☐				☐	☐	☐	☐			☐	☐
WA	☐	☐	☐	☐	☐	☐	☐	☐	☐											
WADWA										☐	☐	☐								
WE	☐	☐	☐																	

# my FANIMATION DISTINCTION™

## 3. Fitters



F1		
BN	DZ	MW



F2		
BN	DZ	MW



F3		
BN	DZ	MW



F4*		
BN	DZ	MW

## 4. Glass



	G1	G2	G3	G1	G4	G5	G6
CL			⊕		⊕		⊕
MS	⊕			⊕			
OP		⊕	⊕			⊕	⊕
OPS			⊕		⊕		
TST	⊕	⊕		⊕	⊕	⊕	⊕

\*Additional glass available on page \_\_\_\_

## 5. Controls



For use with A1 and C1 motors		For use with D1 motor	
<b>BTT9R</b> —included	<b>C25</b> —sold separately	<b>TR205</b> —included	<b>TW206</b> —sold separately
White hand-held remote control with wall mount	White wall control with wall plate	White hand-held remote control with wall mount	White wall control with wall plate

# ZONIX™ WET



**FAN: FP4640OB(1)**  
oil rubbed bronze assembly with cherry all weather composite blades

oil-rubbed bronze

satin nickel

white

cherry

satin nickel

white

**FP4640OB**

**FP4640SN**

**FP4640WH**

INCLUDED:



blade set

ENERGY INFORMATION AT HIGH SPEED:



FANSYNC™ compatible



3-SPEED AC reverse switch on fan



CONTROL pull chain



WET indoor/outdoor

Airflow  
**5432**  
Cubic Feet Per Minute

Electricity Use  
**57**  
Watts (excluding lights)

Airflow Efficiency  
**96**  
Cubic Feet Per Minute Per Watt



LIMITED LIFETIME MOTOR WARRANTY



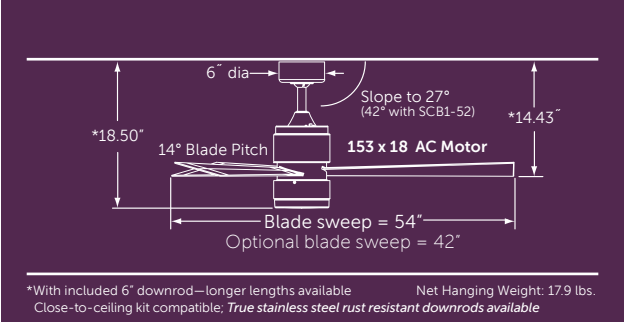

**FAN: FP4650BN (1)**  
brushed nickel assembly with  
brushed nickel blades and  
opal frosted glass



**FAN: FP4650DCP (1)**  
dark copper penny assembly with  
dark walnut blades and  
opal frosted glass



**FAN: FP4650OB (1)**  
oil-rubbed bronze assembly  
with walnut blades and opal  
frosted glass



**SOLD SEPARATELY:**

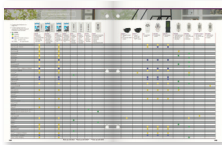

See page 141-146 for  
optional controls

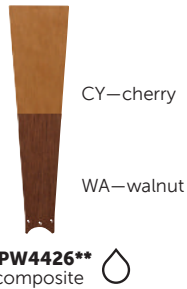

# ZONIX™ LED

**FAN: FP4650BN(1)**  
brushed nickel assembly with  
brushed nickel blades and  
opal frosted glass

brushed  
nickel  
brushed  
nickel  
**FP4650BN**

dark copper  
penny  
dark walnut  
**FP4650DCP**

oil-rubbed  
bronze  
walnut  
**FP4650OB**

  
**FANSYNC™**  
compatible

  
**16W**  
LED

  
**3-SPEED AC**  
reverse switch  
on fan

  
**CONTROL**  
remote

  
**DAMP**  
indoor/outdoor

**INCLUDED:**



blade set



light kit



TR24WH remote

**ENERGY INFORMATION  
AT HIGH SPEED:**

Airflow  
**4436**  
Cubic Feet  
Per Minute

Electricity Use  
**57**  
Watts  
(excluding lights)

Airflow Efficiency  
**78**  
Cubic Feet Per  
Minute Per Watt

**LIMITED LIFETIME MOTOR WARRANTY**



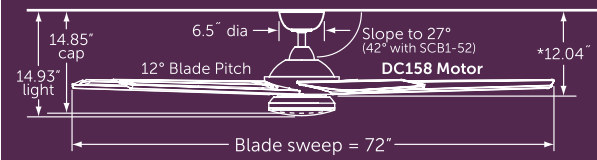

\*With included 6" downrod—longer lengths available  
 True stainless steel rust resistant downrods available

Net Hanging Weight: 26.5 lbs.



**FAN: FPD6236BN (1)**  
 brushed nickel assembly  
 with bourbon blades and  
 opal frosted glass



**FAN: FPD6236DZ (1)**  
 dark bronze assembly  
 with bourbon blades  
 and matching dark  
 bronze cap (included)

**Special features**

 <b>FAN TIMER</b>	Sets timer for fan & light to turn off (max 6 hours)	 <b>HOME AWAY</b>	Light turns on and off at set intervals to simulate someone being home.
 <b>FRESH AIR</b>	Variable fan speeds simulate a natural breeze.	 <b>SAFE EXIT</b>	Fan & light will turn off after one minute to allow for safe exit

**SOLD SEPARATELY:**

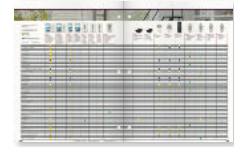

See page 141-146 for optional controls

# SUBTLE™



**FAN: FPD6236DZ (1)**  
dark bronze assembly with bourbon blades and opal frosted glass

brushed nickel

dark bronze

bourbon

bourbon

**FPD6236BN**

**FPD6236DZ**



ENERGY SAVINGS



FAN SYNC™  
included



18W  
LED



31-SPEED DC  
reverse switch  
on remote



CONTROL  
remote



DAMP  
indoor/outdoor

INCLUDED:



blade set



light kit



light cover



TR205 remote

ENERGY INFORMATION  
AT HIGH SPEED:

Airflow

**6802**

Cubic Feet  
Per Minute

Electricity Use

**41**

Watts  
(excluding lights)

Airflow Efficiency

**168**

Cubic Feet Per  
Minute Per Watt



LIMITED LIFETIME MOTOR WARRANTY



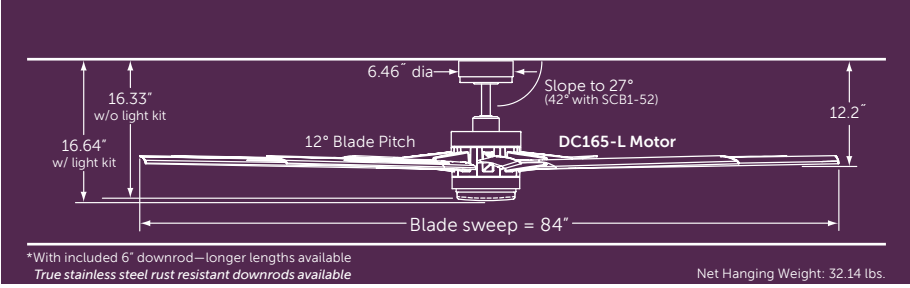

**FAN: FP8149BNWBL (1)**  
brushed nickel assembly  
with black blades and opal  
frosted glass



**FAN: FPD8149BNWBN (1)**  
brushed nickel assembly with  
brushed nickel blades and matching  
brushed nickel light cover (included)



**FAN: FPD8149DZW (1)**  
dark bronze assembly with  
dark walnut blades and opal  
frosted glass



**FAN: FPD8149GRW (1)**  
matte greige assembly with weathered  
wood blades and matching matte  
greige light cover (included)



**FAN: FPD8149MWW (1)**  
matte white assembly with  
matte white blades and opal  
frosted glass



**SOLD SEPARATELY:**

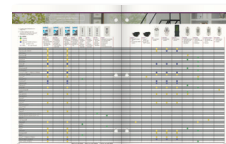

See page 141-146 for  
optional controls



# ODYN™



**FAN: FPD8149GRW (1)**  
matte greige assembly with weathered wood blades and opal frosted glass

brushed nickel	brushed nickel	dark bronze	matte greige	matte white
black	brushed nickel	dark walnut	weathered wood	matte white
FPD8149BNWBL	FPD8149BNWBN	FPD8149DZW	FPD8149GRW	FPD8149MWW

- ENERGY SAVINGS
- 18W LED
- 6-SPEED DC reverse switch on remote
- CONTROL remote
- WET indoor/outdoor

**INCLUDED:**

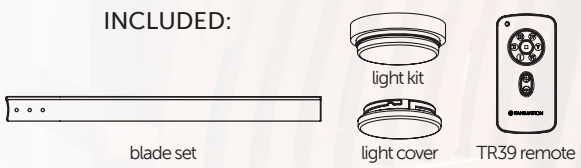

**ENERGY INFORMATION AT HIGH SPEED:**

Airflow	Electricity Use	Airflow Efficiency
<b>11,190</b>	<b>32</b>	<b>348</b>
Cubic Feet Per Minute	Watts (excluding lights)	Cubic Feet Per Minute Per Watt



**LIMITED LIFETIME MOTOR WARRANTY**



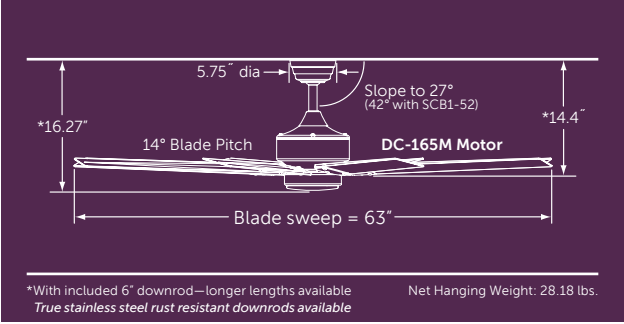

**FAN: FPD7916BN (1)**  
brushed nickel assembly  
with brushed nickel blades  
and opal frosted glass



**FAN: FPD7916DZ (1)**  
dark bronze assembly with  
dark walnut blades and  
opal frosted glass

**SOLD SEPARATELY:**

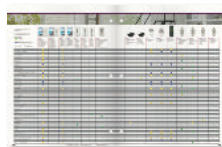

See page 141-146 for  
optional controls

# LEVON™ DC



**FAN: FPD7916BN** (1)  
brushed nickel assembly  
with brushed nickel blades  
and opal frosted glass

brushed  
nickel

dark  
bronze

brushed  
nickel

dark  
walnut

**FPD7916BN**

**FPD7916DZ**

INCLUDED:



blade set



light kit



TR39 remote

ENERGY INFORMATION  
AT HIGH SPEED:

ENERGY SAVINGS

18W  
LED

6-SPEED DC  
reverse switch  
on remote

CONTROL  
remote

DAMP  
indoor/outdoor

Airflow  
**7817**  
Cubic Feet  
Per Minute

Electricity Use  
**34**  
Watts  
(excluding lights)

Airflow Efficiency  
**230**  
Cubic Feet Per  
Minute Per Watt



LIMITED LIFETIME MOTOR WARRANTY



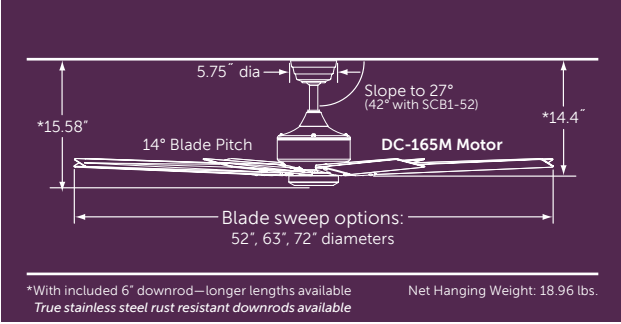

**FAN: MAD7912BN** (1)  
brushed nickel assembly  
**BLADES: B7913BN** (1)  
72" sweep brushed nickel  
buttonwood  
**LIGHT KIT: LK7912BN** (1)  
18W dimmable LED



**FAN: MAD7912DZ** (1)  
dark bronze assembly  
**BLADES: B7913CYWA** (1)  
72" sweep cherry/walnut  
reversible buttonwood  
● cherry side showing



**FAN: MAD7912MW** (1)  
matte white assembly  
**BLADES: B7912N** (1)  
63" sweep natural buttonwood



**FAN: MAD7912DZ** (1)  
dark bronze assembly  
**BLADES: B7914CYWA** (1)  
52" sweep cherry/walnut  
reversible buttonwood  
● walnut side showing



**SOLD SEPARATELY:**

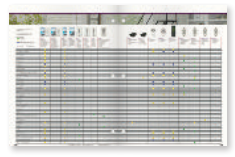

See page 141-146 for optional controls



**B7912\*\***  
buttonwood

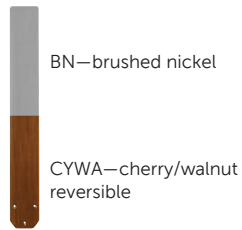

**B7913\*\***  
buttonwood

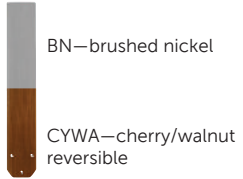

**B7914\*\***  
buttonwood

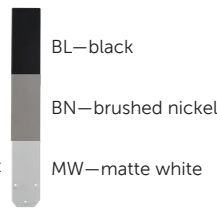

**BPW7912\*\***  
composite







**LK7912\*\***  
18W LED

# LEVON™ CUSTOM



 **FAN: MAD7912MW** (1)  
 matte white assembly  
**BLADES: B7913CYWA** (1)  
 72" sweep reversible cherry/walnut  
 ● walnut side showing  
**LIGHT KIT: LK7912MW** (1)  
 18W dimmable LED

brushed nickel	dark bronze	matte white
<b>MAD7912BN</b>	<b>MAD7912DZ</b>	<b>MAD7912MW</b>

-   
**ENERGY SAVINGS**
-   
**MIX & MATCH**  
 components  
 sold separately
-   
**6-SPEED DC**  
 reverse switch  
 on remote
-   
**CONTROL**  
 remote
-   
**DAMP**  
 indoor/outdoor

INCLUDED:



TR39 remote

### ENERGY INFORMATION AT HIGH SPEED:

Airflow measured with  
BPW912\*\* blades

Airflow  
**7695**  
 Cubic Feet  
 Per Minute

Electricity Use  
**34**  
 Watts  
 (excluding lights)

Airflow Efficiency  
**226**  
 Cubic Feet Per  
 Minute Per Watt



**LIMITED LIFETIME MOTOR WARRANTY**



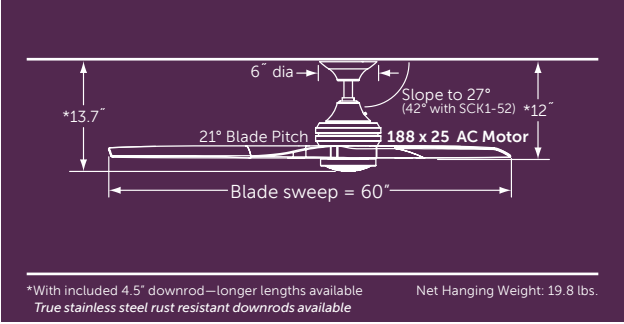

**FAN: MA6721BN** (1)  
brushed nickel assembly  
**BLADES: B6720BN** (1)  
brushed nickel finish buttonwood



**FAN: MA6721BS** (1)  
brushed satin assembly  
**BLADES: B6720WK** (1)  
whiskey wood finish buttonwood



**FAN: MA6721DF** (1)  
driftwood assembly  
**BLADES: B6720DF** (1)  
driftwood finish buttonwood



**FAN: MA6721DZ** (1)  
dark bronze assembly  
**BLADES: B6720N** (1)  
natural finish buttonwood



**FAN: MA6721GR** (1)  
matte greige assembly  
**BLADES: B6720WE** (1)  
weathered wood finish buttonwood



**SOLD SEPARATELY:**

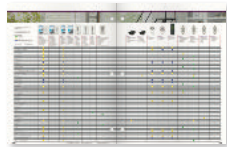

See page 141-146 for optional controls



**B6720\*\*** button wood

- BN—brushed nickel
- DF—driftwood
- DWA—dark walnut
- N—natural
- WE—weathered wood
- WK—whiskey wood



**LK6721\*\*** 18W LED

# SPITFIRE™



**FAN: MA6721DZ** (1)  
dark bronze assembly  
**BLADES: B6720N** (1)  
natural finish buttonwood  
**LIGHT KIT: LK6721DZ** (1)  
dark bronze with frosted fresnel glass

- brushed  
nickel  
**MA6721BN**
- brushed  
satin  
**MA6721BS**
- driftwood  
**MA6721DF**
- dark  
bronze  
**MA6721DZ**
- matte  
greige  
**MA6721GR**

- FANSYNC™**  
included
- MIX & MATCH**  
components  
sold separately
- 3-SPEED AC**  
reverse switch  
on fan
- CONTROL**  
remote
- DAMP**  
indoor/outdoor



## ENERGY INFORMATION AT HIGH SPEED:

Airflow	Electricity Use	Airflow Efficiency
<b>6641</b>	<b>61</b>	<b>108</b>
Cubic Feet Per Minute	Watts (excluding lights)	Cubic Feet Per Minute Per Watt



**LIMITED LIFETIME MOTOR WARRANTY**



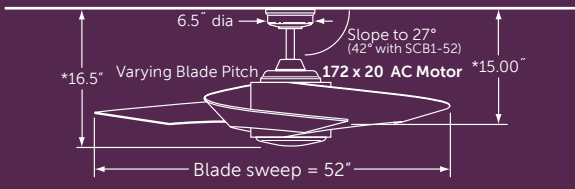

\*With included 6" downrod—longer lengths available Net Hanging Weight: 27.4 lbs.  
Close-to-ceiling kit compatible; True stainless steel rust resistant downrods available

NOTE: AIRFLOW MOVES OUTWARD AT AN ANGLE INSTEAD OF DIRECTLY DOWNWARD

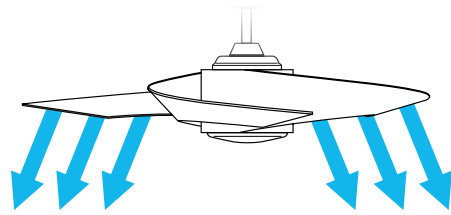

**FAN: FP7900BL (1)**  
black assembly with  
opal frosted glass



**FAN: FP7900MG (1)**  
metro gray assembly  
with opal frosted glass



**FAN: FP7900MW (1)**  
matte white assembly  
with opal frosted glass



**FAN: FP7900OB (1)**  
oil-rubbed bronze assembly  
with opal frosted glass



SOLD SEPARATELY:



See page 141-146 for  
optional controls





# TORTO™

FAN: FP7900BL (1)  
black assembly with  
opal frosted glass

black	metro gray	matte white	oil-rubbed bronze
black	metro gray	matte white	oil-rubbed bronze
<b>FP7900BL</b>	<b>FP7900MG</b>	<b>FP7900MW</b>	<b>FP7900OB</b>

  
FANSYNC™  
compatible

  
(2) 60W  
incandescent  
candelabra

  
3-SPEED AC  
reverse switch  
on remote

  
CONTROL  
remote

  
DAMP  
indoor/outdoor

**INCLUDED:**



blade set



light kit



TR20WH remote

**ENERGY INFORMATION  
AT HIGH SPEED:**

Airflow  
**4425**  
Cubic Feet  
Per Minute

Electricity Use  
**80**  
Watts  
(excluding lights)

Airflow Efficiency  
**56**  
Cubic Feet Per  
Minute Per Watt

**LIMITED LIFETIME MOTOR WARRANTY**



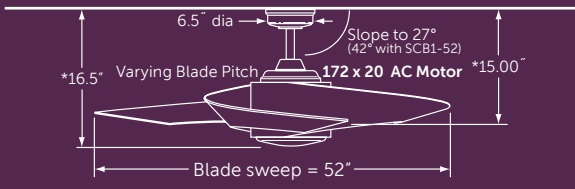

\*With included 6" downrod—longer lengths available Net Hanging Weight: 27.4 lbs.  
Close-to-ceiling kit compatible; *True stainless steel rust resistant downrods available*

NOTE: AIRFLOW MOVES OUTWARD AT AN ANGLE INSTEAD OF DIRECTLY DOWNWARD

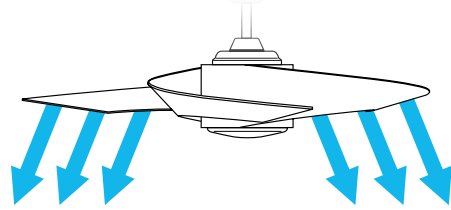

**FAN: FP7902BN (1)**  
brushed nickel assembly with  
18W LED opal frosted glass  
and fanSync fan control

SOLD SEPARATELY:





See page 141-146 for  
optional controls

# TORTO™ LED

**FAN: FP7902BN(1)**  
 brushed nickel assembly with  
 18W LED opal frosted glass  
 and fanSync fan control

brushed nickel  
 brushed nickel  
**FP7902BN**

-  **FANSYNC™** included
-  **18W LED**
-  **3-SPEED AC** reverse switch on remote
-  **CONTROL** remote
-  **DAMP** indoor/outdoor

**INCLUDED:**

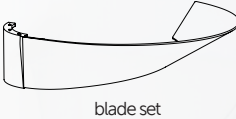

blade set



light kit



BTT9R

**ENERGY INFORMATION AT HIGH SPEED:**

Airflow	Electricity Use	Airflow Efficiency
<b>4425</b>	<b>80</b>	<b>56</b>
Cubic Feet Per Minute	Watts (excluding lights)	Cubic Feet Per Minute Per Watt

**LIMITED LIFETIME MOTOR WARRANTY**



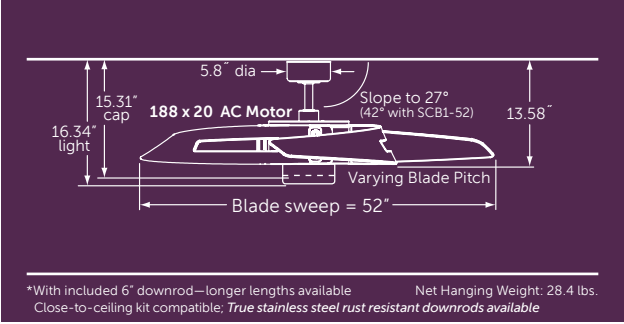

 **FAN: FP6210SN** (1)  
satin nickel assembly  
with walnut blades  
and opal frosted glass



 **FAN: FP6210OB** (1)  
oil-rubbed bronze assembly  
with cherry blades and opal  
frosted glass



 **FAN: FP6210SN** (1)  
satin nickel assembly with  
walnut blades and matching  
light cover (included)



**SOLD SEPARATELY:**

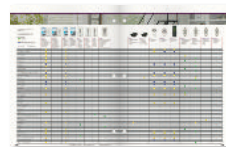

See page 141-146 for  
optional controls

# AVASTON™

**FAN: FP6210OB** (1)  
oil-rubbed bronze assembly  
with cherry blades and  
matching light cover (included)

oil-rubbed bronze	satin nickel
cherry <b>FP6210OB</b>	walnut <b>FP6210SN</b>

- FANSYNC™**  
compatible
- (2) 50W**  
halogen  
minican
- 3-SPEED AC**  
reverse switch  
on fan
- CONTROL**  
remote
- DAMP**  
indoor/outdoor

**INCLUDED:**

- blade set
- light kit
- light cover
- TR24WH remote

**ENERGY INFORMATION  
AT HIGH SPEED:**

Airflow	Electricity Use	Airflow Efficiency
<b>5309</b>	<b>73</b>	<b>72</b>
Cubic Feet Per Minute	Watts (excluding lights)	Cubic Feet Per Minute Per Watt

**LIMITED LIFETIME MOTOR WARRANTY**



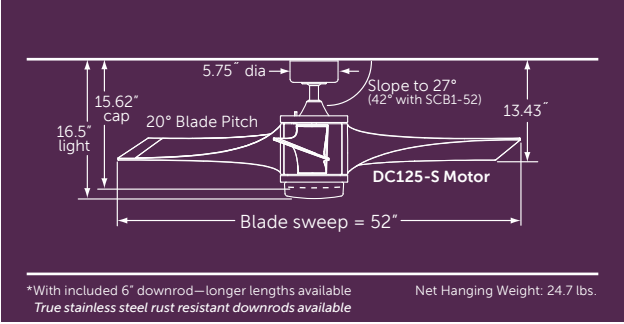

**FAN: FPD7943MG (1)**  
metro gray assembly  
with metro gray blades  
and opal frosted glass



**FAN: FPD7943OB (1)**  
oil-rubbed bronze assembly  
with oil-rubbed bronze  
blades and opal frosted glass



**FAN: FPD7943MG (1)**  
metro gray assembly with  
metro gray blades and  
matching light cover (included)



**SOLD SEPARATELY:**

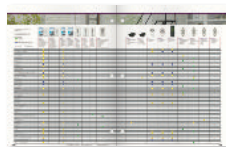

See page 141-146 for  
optional controls



# JENNIX™

**FAN: FPD7943OB (1)**  
oil-rubbed bronze assembly with oil-rubbed bronze blades and matching light cover (included)

metro gray	oil-rubbed bronze
metro gray	oil-rubbed bronze
<b>FPD7943MG</b>	<b>FPD7943OB</b>

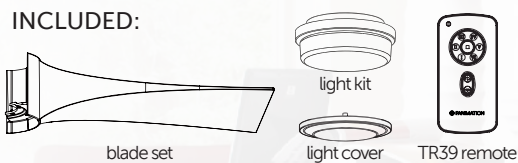
**INCLUDED:**



				
<b>ENERGY SAVINGS</b>	<b>(1) 100W halogen minican</b>	<b>6-SPEED DC reverse switch on remote</b>	<b>CONTROL remote</b>	<b>DAMP indoor/outdoor</b>

**ENERGY INFORMATION AT HIGH SPEED:**

Airflow	Electricity Use	Airflow Efficiency
<b>5239</b>	<b>30</b>	<b>178</b>
Cubic Feet Per Minute	Watts (excluding lights)	Cubic Feet Per Minute Per Watt

**LIMITED LIFETIME MOTOR WARRANTY**



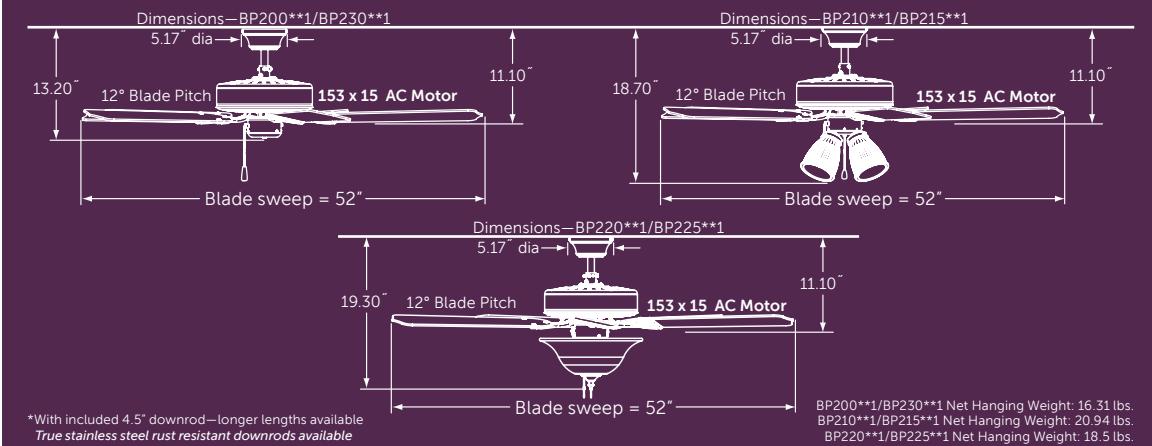

- FAN: BP200SN1 (1)**  
satin nickel assembly in flush-mount configuration with reversible cherry/walnut wood blades
  - walnut side showing



- FAN: BP210MW1 (1)**  
matte white assembly in downrod configuration with white frosted glass shades and matte white wood blades



- FAN: BP215OB1 (1)**  
oil-rubbed bronze assembly in downrod configuration with white frosted glass shades (amber shades version available: BP210OB1) and reversible cherry/walnut wood blades
  - cherry side showing



- FAN: BP230BL1 (1)**  
black assembly in downrod configuration with black blades



SOLD SEPARATELY:

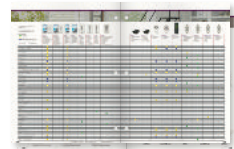

control options: p.141-146  
light options: p.139-140



# AIRE DECOR®



**FAN: BP220SN1 (1)**  
satin nickel assembly in downrod configuration with white frosted glass bowl and reversible cherry/walnut blades  
● walnut side showing



**FAN: BP220MW1 (1)**  
matte white assembly in downrod configuration with white frosted glass bowl and matte white wood blades



**FAN: BP225OB1 (1)**  
oil-rubbed bronze assembly in downrod configuration with white frosted glass bowl (amber glass version available: BP220OB1) and cherry/walnut reversible wood blades  
● walnut side showing

black	matte white	oil-rubbed bronze	oil-rubbed bronze	satin nickel	satin nickel
black	matte white	cherry walnut	walnut	cherry walnut	cherry
BP230BL1	BP200MW1 BP210MW1 BP220MW1 BP230MW1	BP200OB1 BP210OB1 BP215OB1 BP220OB1 BP225OB1	BP230OB1	BP200SN1 BP210SN1 BP220SN1	BP230SN1

- FANSYNC™ compatible
- SEE INCLUDED incandescent candelabra
- 3-SPEED AC reverse switch on fan
- CONTROL pull chain
- DRY OR DAMP model specific

## INCLUDED:



## ENERGY INFORMATION AT HIGH SPEED:

Airflow	Electricity Use	Airflow Efficiency
<b>5849</b>	<b>64</b>	<b>91</b>
Cubic Feet Per Minute	Watts (excluding lights)	Cubic Feet Per Minute Per Watt

LIMITED LIFETIME MOTOR WARRANTY



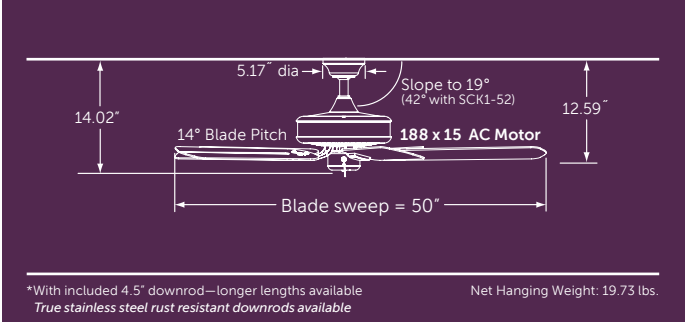

**FAN: TF910AZ** (1)  
aged bronze assembly with  
dark cherry all-weather  
composite blades



**FAN: TF910BL** (1)  
black assembly with  
black all-weather  
composite blades



**FAN: TF910OB** (1)  
oil-rubbed bronze assembly  
with dark cherry all-weather  
composite blades



**FAN: TF910WH** (1)  
white assembly with  
white all-weather  
composite blades



**SOLD SEPARATELY:**

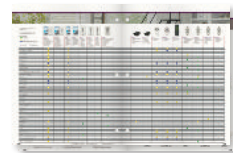

control options: p.141-146  
light options: p.139-140

# EDGEWOOD® WET



**FAN: TF910WH(1)**  
white assembly with all-weather composite white blades

aged bronze	black	oil-rubbed bronze	white
dark cherry	black	dark cherry	white
<b>TF910AZ</b>	<b>TF910BL</b>	<b>TF910OB</b>	<b>TF910WH</b>

INCLUDED:

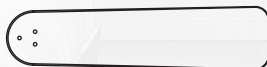

blade set

ENERGY INFORMATION  
AT HIGH SPEED:

FANSYNC™ compatible	3-SPEED AC reverse switch on fan	CONTROL pull chain	WET indoor/outdoor

Airflow	Electricity Use	Airflow Efficiency
<b>5461</b>	<b>54</b>	<b>102</b>
Cubic Feet Per Minute	Watts (excluding lights)	Cubic Feet Per Minute Per Watt



LIMITED LIFETIME MOTOR WARRANTY



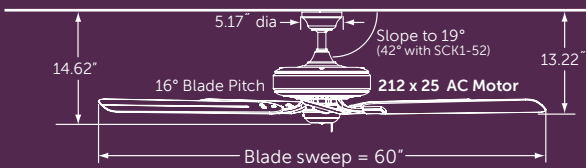

\*With included 4.5" downrod—longer lengths available Net Hanging Weight: 32.1 lbs.  
Close-to-ceiling kit compatible; True stainless steel rust resistant downrods available



**FAN: TF971AZ (1)**  
aged bronze assembly with  
dark cherry all-weather  
composite blades



**FAN: TF971OB (1)**  
oil-rubbed bronze assembly  
with dark cherry all-weather  
composite blades

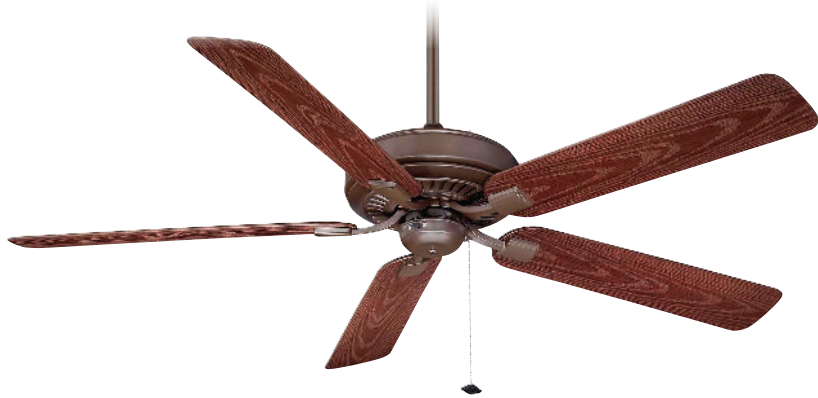

**FAN: TF971WH (1)**  
white assembly with  
white all-weather  
composite blades



**SOLD SEPARATELY:**

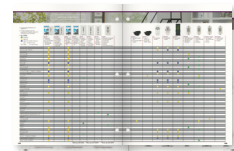

control options: p.141-146  
light options: p.139-140



# EDGEWOOD® DELUXE WET



**FAN: TF971AZ** (1)  
aged bronze assembly with  
all-weather composite  
dark cherry blades

aged  
bronze

**TF971AZ**

oil-rubbed  
bronze

dark  
cherry

**TF971OB**

white

white

**TF971WH**



**FANSYNC™**  
compatible



**3-SPEED AC**  
reverse switch  
on fan



**CONTROL**  
pull chain



**WET**  
indoor/outdoor

**INCLUDED:**



blade set

**ENERGY INFORMATION  
AT HIGH SPEED:**

Airflow  
**8963**  
Cubic Feet  
Per Minute

Electricity Use  
**107**  
Watts  
(excluding lights)

Airflow Efficiency  
**84**  
Cubic Feet Per  
Minute Per Watt



**LIMITED LIFETIME MOTOR WARRANTY**



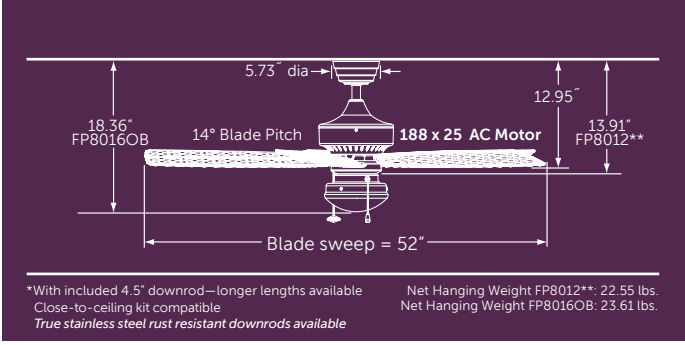

**FAN: FP8012OB (1)**  
oil-rubbed bronze assembly with all-weather composite antique woven bamboo blades



**FAN: FP8012WH (1)**  
white assembly with all-weather composite white woven bamboo blades

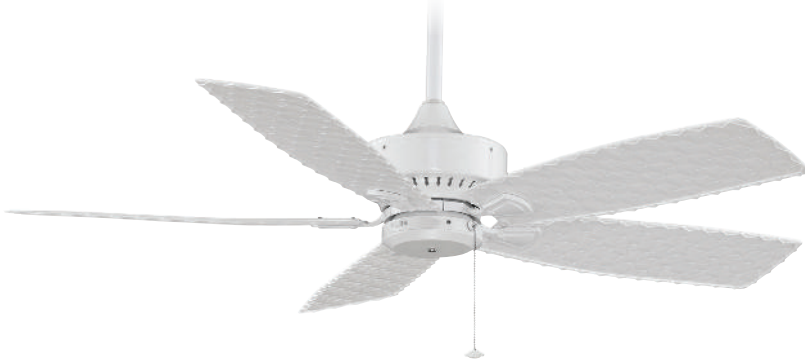

**FAN: FP8016OB (1)**  
oil-rubbed bronze assembly with frosted white low profile light kit and all-weather composite antique woven bamboo blades



**SOLD SEPARATELY:**

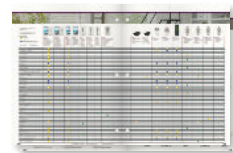

control options: p.141-146  
light options: p.139-140

# CANCUN™ WET

**FAN: FP8016OB (1)**  
oil-rubbed bronze assembly with frosted white low profile light kit and all-weather composite antique woven bamboo blades

oil-rubbed bronze  
antique bamboo  
**FP8012OB**  
**FP8016OB**

white  
white bamboo  
**FP8012WH**  
**FP8016OB**

  
FANSYNC™  
compatible

  
(2) 75W  
halogen  
minican  
FP8016OB

  
3-SPEED AC  
reverse switch  
on fan

  
CONTROL  
pull chain

  
WET  
indoor/outdoor

**INCLUDED:**



blade set



light kit—FP8016OB only

**ENERGY INFORMATION  
AT HIGH SPEED:**

Airflow  
**5715**  
Cubic Feet  
Per Minute

Electricity Use  
**70**  
Watts  
(excluding lights)

Airflow Efficiency  
**82**  
Cubic Feet Per  
Minute Per Watt

FP8012\*\* only



**LIMITED LIFETIME MOTOR WARRANTY**



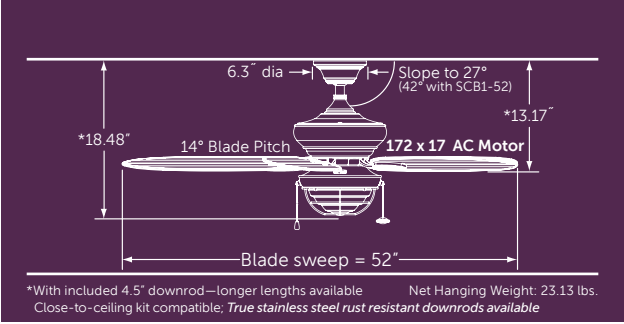

**FAN: FP7963RS (1)**  
rust assembly with  
cherry bronze blades  
and opal frosted glass

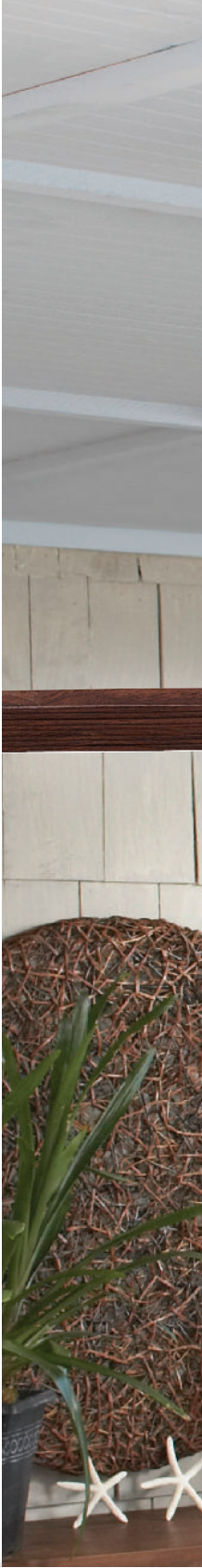

**SOLD SEPARATELY:**

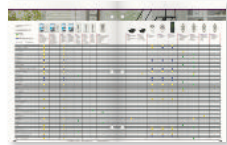

See page 141-146 for  
optional controls



# KAYA™

**FAN: FP7963RS (1)**  
rust assembly with  
cherry bronze blades  
and opal frosted glass

rust  
cherry  
bronze  
**FP7963RS**

  
FANSYNC™  
compatible

  
(1) 26W  
GU24 CFL

  
3-SPEED AC  
reverse switch  
on fan

  
CONTROL  
pull chain

  
WET  
indoor/outdoor

## INCLUDED:



blade set



light kit

## ENERGY INFORMATION AT HIGH SPEED:

Airflow  
**4995**  
Cubic Feet  
Per Minute

Electricity Use  
**65**  
Watts  
(excluding lights)

Airflow Efficiency  
**77**  
Cubic Feet Per  
Minute Per Watt

LIMITED LIFETIME MOTOR WARRANTY



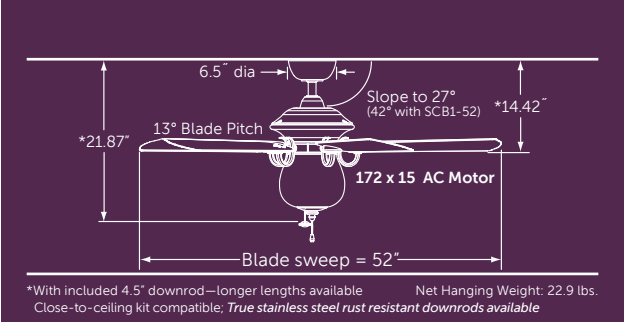

**FAN: FP7954OB (1)**  
oil-rubbed bronze assembly with seeded glass light kit and reversible cherry/walnut composite blades

- cherry side showing



**FAN: FP7954OB (1)**  
oil-rubbed bronze assembly with seeded glass light kit and reversible cherry/walnut composite blades

- walnut side showing

**SOLD SEPARATELY:**

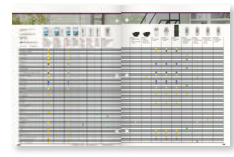

See page 141-146 for optional controls

# CRESTFORD™

**FAN: FP7954OB** (1)  
oil-rubbed bronze assembly  
with seeded glass light kit  
and reversible cherry/walnut  
composite blades  
• cherry side showing

oil-rubbed  
bronze  
cherry/walnut  
**FP7954OB**

  
**FANSYNC™**  
compatible

  
**(3) 40W**  
incandescent  
candelabra

  
**3-SPEED AC**  
reverse switch  
on fan

  
**CONTROL**  
pull chain

  
**WET**  
indoor/outdoor

## INCLUDED:

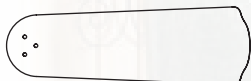

blade set



light kit

## ENERGY INFORMATION AT HIGH SPEED:

Airflow  
**5803**  
Cubic Feet  
Per Minute

Electricity Use  
**59**  
Watts  
(excluding lights)

Airflow Efficiency  
**99**  
Cubic Feet Per  
Minute Per Watt

**LIMITED LIFETIME MOTOR WARRANTY**



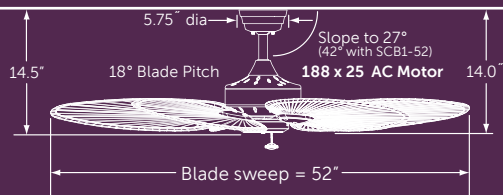

\*With included 6" downrod—longer lengths available  
 Close-to-ceiling kit compatible  
 True stainless steel rust resistant downrods available

FP7500AB Net Hanging Weight: 23.84 lbs.  
 FP7500MW Net Hanging Weight: 26.66 lbs.  
 FP7500OBP4 Net Hanging Weight: 29.87 lbs.  
 FP7500RS Net Hanging Weight: 25.41 lbs.

**FAN: FP7500AB (1)**  
 52" sweep antique brass assembly  
 with natural palm narrow oval blades

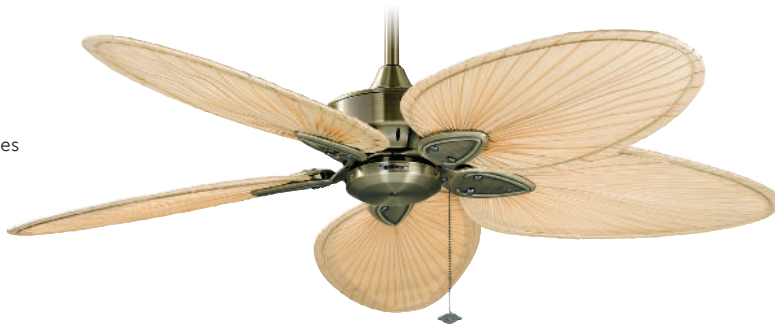

**FAN: FP7500MW (1)**  
 52" sweep matte white assembly  
 with natural palm narrow oval blades



**FAN: FP7500OBP4 (1)**  
 52" sweep oil-rubbed bronze  
 assembly with all weather composite  
 red/brown narrow oval palm blades



**FAN: FP7500RS (1)**  
 52" sweep rust assembly with antique  
 woven bamboo narrow oval blades



**SOLD SEPARATELY:**

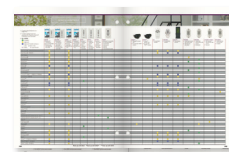

control options: p.141-146  
 light options: p.139-140

# WINDPOINTE®



**FAN: FP7500AB (1)**  
52" sweep antique brass assembly with natural narrow oval palm blades

antique brass natural palm FP7500AB	matte white natural palm FP7500MW	oil-rubbed bronze red/brown palm FP7500BP4	rust antique bamboo FP7500RS
---	---	--	------------------------------------

  
**FANSYNC™**  
compatible

  
**3-SPEED AC**  
reverse switch  
on fan

  
**CONTROL**  
pull chain

  
**DRY OR DAMP**  
model specific

**INCLUDED:**

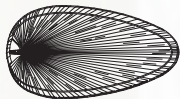

blade set

**ENERGY INFORMATION**  
AT HIGH SPEED:

	Airflow	Electricity Use	Airflow Efficiency
FP7500AB	<b>2633</b>	<b>42</b>	<b>63</b>
FP7500MW	<b>2812</b>	<b>42</b>	<b>67</b>
FP7500BP4	<b>4054</b>	<b>50</b>	<b>81</b>
FP7500RS	<b>2551</b>	<b>42</b>	<b>60</b>
	Cubic Feet Per Minute	Watts (excluding lights)	Cubic Feet Per Minute Per Watt

**LIMITED LIFETIME MOTOR WARRANTY**



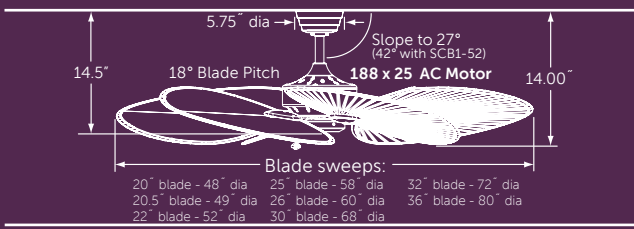

\*With included 6" downrod—longer lengths available Net Hanging Weight: 24.87 lbs.  
Close-to-ceiling kit compatible; True stainless steel rust resistant downrods available

**FAN: MA7500AB** (1)  
antique brass assembly  
**BLADES: B5340WA** (1)  
52" sweep walnut carved wood



**FAN: MA7500MW** (1)  
matte white assembly  
**BLADES: BPW6090DNA** (1)  
60" sweep all-weather composite dark natural accent narrow palm



**FAN: MA7500OB** (1)  
oil-rubbed bronze assembly  
**BLADES: BPW20CY** (1)  
48" sweep all-weather composite cherry  
**LIGHT KIT: LKLP102OB** (1)  
opal frosted glass low profile  
**CLOSE TO CEILING KIT: CCK8002OB** (1)  
oil-rubbed bronze



**FAN: MA7500PW** (1)  
pewter assembly  
**BLADES: ISD1A** (1)  
52" sweep antique wide oval woven bamboo



**FAN: MA7500RS** (1)  
rust assembly  
**BLADES: B5280WA** (1)  
52" sweep walnut wide oval leaf carved wood



**SOLD SEPARATELY:**



blade options: p.149-150  
control options: p.141-146  
light options: p.139-140

# WINDPOINTE® CUSTOM

**FAN: MA7500MW** (1)  
matte white assembly  
**BLADES: BPW6090DNA** (1)  
60" sweep all-weather  
composite dark natural  
accent narrow palm

antique brass MA7500AB    matte white MA7500MW    oil-rubbed bronze MA7500OB    pewter MA7500PW    rust MA7500RS



FANSYNC™  
compatible



MIX & MATCH  
components  
sold separately

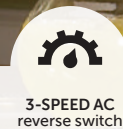

3-SPEED AC  
reverse switch  
on fan



CONTROL  
pull chain

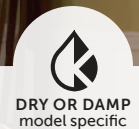

DRY OR DAMP  
model specific

**ENERGY INFORMATION  
AT HIGH SPEED:**  
Airflow measured with  
B5280WA blades

Airflow  
**4649**  
Cubic Feet  
Per Minute

Electricity Use  
**46**  
Watts  
(excluding lights)

Airflow Efficiency  
**101**  
Cubic Feet Per  
Minute Per Watt

LIMITED LIFETIME MOTOR WARRANTY



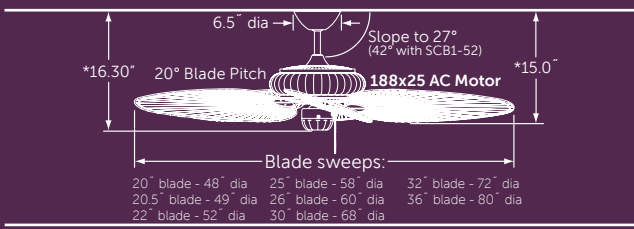

\*With included 6" downrod—longer lengths available Net Hanging Weight: 25.0 lbs.  
Close-to-ceiling kit compatible; True stainless steel rust resistant downrods available

**FAN: FP4320AZ1** (1)  
aged bronze assembly  
**BLADES: BPD4A** (1)  
52" sweep all-weather  
composite antique woven  
bamboo narrow oval

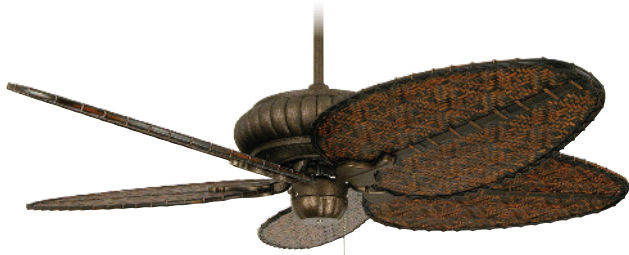

**FAN: FP4320MW1** (1)  
matte white assembly  
**BLADES: BPP4TN** (1)  
52" sweep natural palm  
finish narrow oval all-  
weather composite



**FAN: FP4320TB1** (1)  
textured black assembly  
**BLADES: BPP4BR** (1)  
52" sweep brown/red palm  
narrow oval all-weather  
composite



**FAN: FP4320TS1** (1)  
tortoise shell assembly  
**BLADES: B5340WA** (1)  
52" sweep walnut  
carved wood



SOLD SEPARATELY:



blade options: p.149-150  
control options: p.141-146  
light options: p.139-140



# BELLERIA®

**FAN: FP4320AZ1** (1)  
aged bronze assembly  
**BLADES: BPW6090DNA** (1)  
60" sweep all-weather composite  
dark natural accent narrow palm

aged  
bronze

**FP4320AZ1**

matte  
white

**FP4320MW1**

textured  
black

**FP4320TB1**

tortoise  
shell

**FP4320TS1**



FANSYNC™  
compatible



MIX & MATCH  
components  
sold separately



3-SPEED AC  
reverse switch  
on fan



CONTROL  
pull chain



DRY or WET  
blade finish  
specific

## ENERGY INFORMATION AT HIGH SPEED:

Airflow measured with  
BPW6090DNA blades

Airflow

**5217**

Cubic Feet  
Per Minute

Electricity Use

**68**

Watts  
(excluding lights)

Airflow Efficiency

**77**

Cubic Feet Per  
Minute Per Watt

LIMITED LIFETIME MOTOR WARRANTY



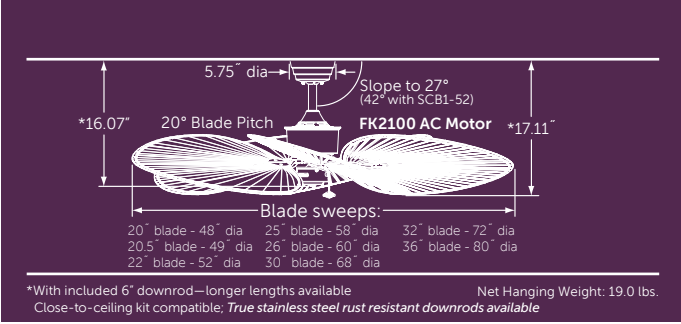

**FAN: FP320AB1** (1)  
antique brass assembly  
**BLADES: ISP1** (1)  
52" sweep natural palm leaf wide oval

**FAN: FP320OB1** (1)  
oil-rubbed bronze assembly  
**BLADES: BPW20CY** (1)  
48" sweep all-weather composite cherry

**FAN: FP320PW1** (1)  
pewter assembly  
**BLADES: B5133TKMH** (1)  
52" sweep reversible teak/  
mahogany wood blades  
● teak side showing

**FAN: FP320RS1** (1)  
rust assembly  
**BLADES: ISD1A** (1)  
52" sweep antique wide oval  
woven bamboo

**FAN: FP320SN1** (1)  
satin nickel assembly  
**BLADES: ISD1A** (1)  
52" sweep antique wide oval woven  
bamboo



**SOLD SEPARATELY:**



blade options: p.149-150  
control options: p.141-146  
light options: p.139-140

# ISLANDER® AC

 **FAN: FP320RS1** (1)  
 rust assembly  
**BLADE SET: ISP1** (1)  
 52" sweep natural palm  
 leaf wide oval

EMULATION

antique brass

**FP320AB1**

oil-rubbed  
bronze

**FP320OB1**

pewter

**FP320PW1**

rust

**FP320RS1**

satin  
nickel

**FP320SN1**



FANSYNC™  
compatible



MIX & MATCH  
components  
sold separately



3-SPEED AC  
reverse switch  
on fan



CONTROL  
pull chain



DRY OR DAMP  
model specific

## ENERGY INFORMATION AT HIGH SPEED:

Airflow measured with  
BPD4A blades

Airflow

**4010**

Cubic Feet  
Per Minute

Electricity Use

**85**

Watts  
(excluding lights)

Airflow Efficiency

**47**

Cubic Feet Per  
Minute Per Watt

LIMITED LIFETIME MOTOR WARRANTY



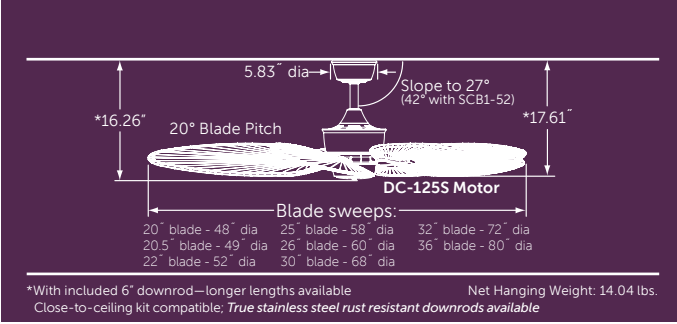

**FAN: MAD3250AB** (1)  
antique brass assembly  
**BLADES: ISP1** (1)  
52" sweep natural palm leaf wide oval  
**FITTER: F423AB** (1)  
antique brass bowl fitter  
**GLASS: G439** (1)  
hand-painted parrot bowl



**FAN: MAD3250BA** (1)  
bronze accent assembly  
**BLADES: ISP4** (1)  
52" sweep natural palm leaf  
narrow oval



**FAN: MAD3250OB** (1)  
oil-rubbed bronze assembly  
**BLADES: BPW6090DNA** (1)  
60" sweep dark natural accent  
narrow palm all-weather  
composite



**FAN: MAD3250PW** (1)  
pewter assembly  
**BLADES: ISD1A** (1)  
52" sweep antique woven bamboo  
wide oval  
**FITTER: F423PW** (1)  
pewter bowl fitter  
**GLASS: G450** (1)  
amber glass bowl



**FAN: MAD3250RS** (1)  
rust assembly  
**BLADES: BPD4A** (1)  
52" sweep antique narrow oval  
composite woven bamboo



**SOLD SEPARATELY:**











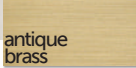

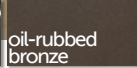
blade options: p.149-150  
control options: p.141-146  
light options: p.139-140

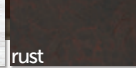
# ISLANDER® DC



**FAN: MAD3250OB** (1)  
oil-rubbed bronze assembly  
**BLADE SET: ISD4A** (1)  
antique narrow oval woven  
bamboo

-   
**MAD3250AB**
-   
**MAD3250BA**
-   
**MAD3250OB**
-   
**MAD3250PW**
-   
**MAD3250RS**

-   
**ENERGY SAVINGS**
-   
**MIX & MATCH**  
components  
sold separately
-   
**6-SPEED DC**  
reverse switch  
on remote
-   
**CONTROL**  
remote
-   
**DRY OR DAMP**  
model specific

INCLUDED:



TR39 remote

### ENERGY INFORMATION AT HIGH SPEED:

Airflow measured with  
BPW6090DNA blades

Airflow  
**5020**  
Cubic Feet  
Per Minute

Electricity Use  
**30**  
Watts  
(excluding lights)

Airflow Efficiency  
**153**  
Cubic Feet Per  
Minute Per Watt



**LIMITED LIFETIME MOTOR WARRANTY**



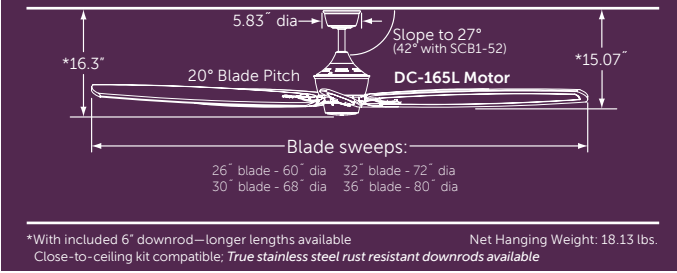

**FAN: MAD3252AB** (1)  
antique brass assembly  
**BLADES: B6841DWA** (1)  
80" sweep dark walnut carved wood



**FAN: MAD3252BN** (1)  
brushed nickel assembly  
**BLADES: B6801DWA** (1)  
80" sweep dark walnut carved wood



**FAN: MAD3252OB** (1)  
oil-rubbed bronze assembly  
**BLADES: B6831WA** (1)  
80" sweep walnut carved wood

**SOLD SEPARATELY:**



additional blade options: p.149-150  
control options: p.141-146  
light options: p.139-140

 <b>BPW6000**</b> composite	 CY—cherry  MH—mahogany  MW—matte white  TK—teak	 WA—walnut <b>B5300**</b> wood	 DWA—dark walnut <b>B6801**</b> wood	 WA—walnut <b>B6831**</b> wood	 DWA—dark walnut <b>B6841**</b> wood
--	---	--	--	--	--

# BIG ISLAND™



**FAN: MAD3252OB** (1)  
oil-rubbed bronze assembly  
**BLADES: B6831WA** (1)  
80" sweep walnut carved wood

antique brass    brushed nickel    oil-rubbed bronze  
**MAD3252AB    MAD3252BN    MAD3252OB**

- ENERGY SAVINGS
- MIX & MATCH components sold separately
- 6-SPEED DC reverse switch on remote
- CONTROL remote
- DRY OR DAMP model specific

INCLUDED:



TR39 remote

**ENERGY INFORMATION AT HIGH SPEED:**  
Airflow measured with BPW6000\*\* blades

Airflow	Electricity Use	Airflow Efficiency
<b>10082</b>	<b>32</b>	<b>318</b>
Cubic Feet Per Minute	Watts (excluding lights)	Cubic Feet Per Minute Per Watt



**LIMITED LIFETIME MOTOR WARRANTY**



For dimensions and configurations, please see our comprehensive Specification Book or model-specific specification sheet, available at [fanimation.com](http://fanimation.com)

- FAN: FP420AB** (1)  
antique brass tall assembly
- BLADE SET: FP1018** (1)  
50" sweep reversible oak/walnut wood blades
- oak side showing



- FAN: FP410BL** (1)  
black short assembly
- BLADE SET: BPP4TN** (1)  
52" sweep natural finish narrow oval all-weather composite palm blades



**SOLD SEPARATELY:**



blade options: p.149-150  
control options: p.141-146  
light options: p.139-140



# AMERICANA®



- ◆ **FAN: FP410AB** (1)  
antique brass short assembly
- ◆ **BLADE SET: FP1018** (1)  
50" sweep reversible oak/  
walnut wood blades
- oak side showing

antique  
brass

**FP410AB**  
**FP420AB**

black

**FP410BL**  
**FP420BL**



**MIX & MATCH**  
components  
sold separately



**3-SPEED AC**  
reverse switch  
on fan



**CONTROL**  
pull chain





**DRY OR DAMP**  
model specific

**LIMITED LIFETIME MOTOR WARRANTY**

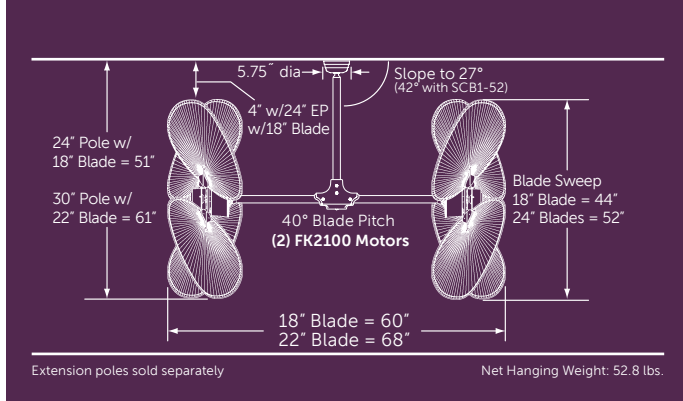



 **FAN: FP240OB** (1)  
 oil-rubbed bronze assembly  
**EXTENSION POLE: EP30OB** (1)  
 30" oil-rubbed bronze  
**BLADES: PAD1A** (1)  
 52" sweep antique wide oval woven bamboo

 **FAN: FP240PW** (1)  
 pewter assembly  
**EXTENSION POLE: EP30PW** (1)  
 30" pewter  
**BLADES: PAD1C** (1)  
 52" sweep clear wide oval woven bamboo  
**ACCESSORY: P48** (1)  
 monkey

 **FAN: FP240RS** (1)  
 rust assembly  
**EXTENSION POLE: EP30RS** (1)  
 30" rust  
**BLADES: PAD1A** (1)  
 52" sweep antique wide oval woven bamboo  
**FILIGREE: FLRS** (1)  
 rust

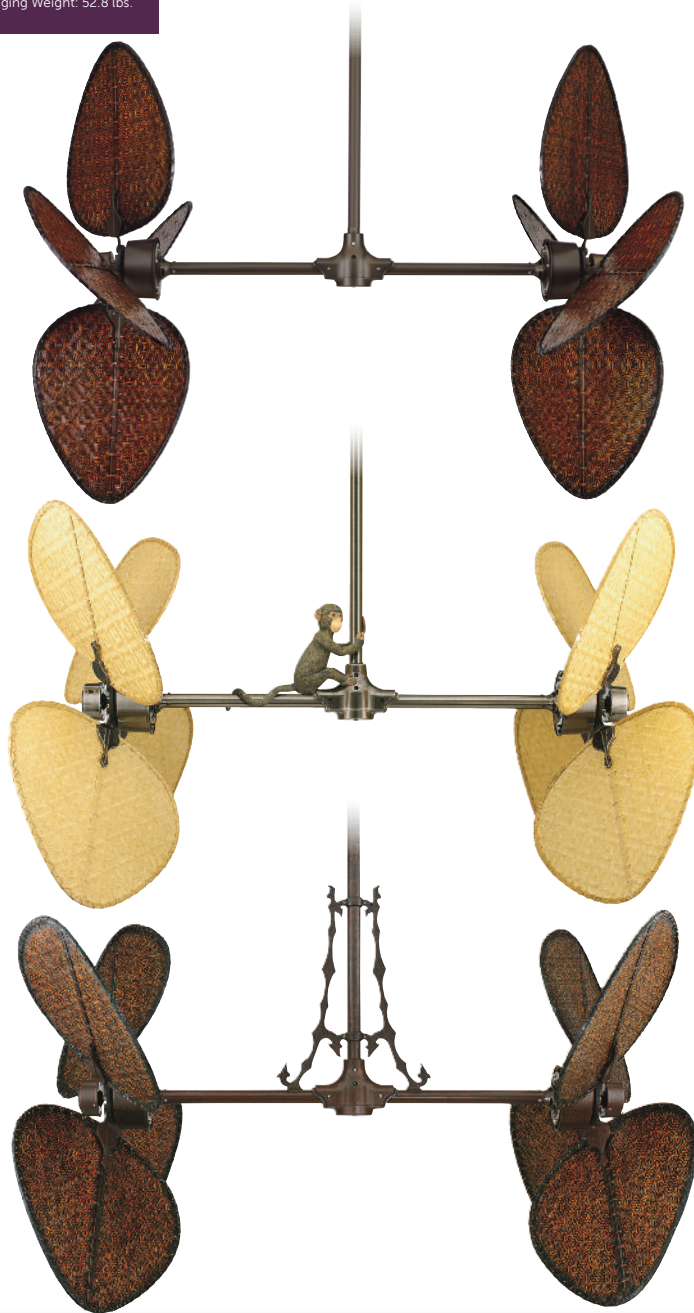

**SOLD SEPARATELY:**



additional blade options: p.149-150  
 control options: p.141-146  
 light options: p.139-140

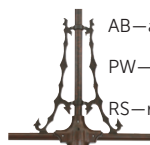

**FL\*\***  
filigree

AB—antique brass   
 PW—pewter   
 RS—rust 



**P48**  
monkey 



**B5080CP**  
cairo purple 



**B5080SS**  
samble sand 



**B5213WA**  
walnut 

# PALISADE®

**FAN:** FP240OB (1)  
oil-rubbed bronze assembly  
**EXTENSION POLE:** EP48OB (1)  
48" oil-rubbed bronze  
**BLADES:** B5080CP (1)  
52" sweep cairo purple wood

oil-rubbed  
bronze  
**FP240OB**

pewter  
**FP240PW**

rust  
**FP240RS**

  
**MIX & MATCH**  
components  
sold separately

  
**3-SPEED AC**  
reverse switch  
on fans

  
**CONTROL**  
wall

  
**DRY OR DAMP**  
model specific

INCLUDED:



CW3WH wall control

LIMITED LIFETIME MOTOR WARRANTY



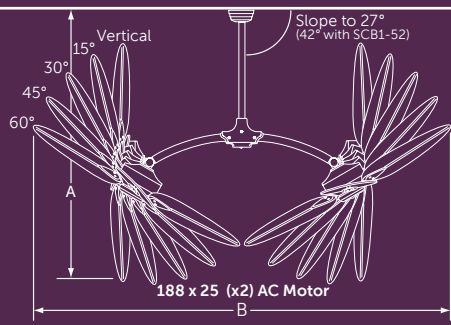

24" downrod included—longer lengths available  
 True stainless steel rust resistant downrods available

Net Hanging Weight: 60 lbs.

Motor Tilt Angle	44" Sweep Blades		49" Sweep Blades		52" Sweep Blades	
	Dim. A w/24" DR	Dim. B w/24" DR	Dim. A w/24" DR	Dim. B w/24" DR	Dim. A w/24" DR	Dim. B w/24" DR
Vertical	54.5"	56.5"	56.5"	56.5"	58.5"	56.5"
15°	55.0"	63.5"	58.0"	64.5"	59.0"	65.5"
30°	54.5"	73.0"	56.0"	75.0"	58.0"	77.0"
45°	52.5"	80.5"	54.0"	83.0"	55.0"	86.0"
60°	49.0"	85.0"	50.0"	88.5"	*51.0"	*92.0"

**FAN: FP7000OB** (1)  
 oil-rubbed bronze assembly  
 (motor heads at 30°)  
**BLADES: CABPP4BR** (1)  
 52" sweep bronze/red all-weather  
 composite oval palm



**FAN: FP7000OB** (1)  
 oil-rubbed bronze assembly  
 (motor heads vertical)  
**BLADES: CAISD2A** (1)  
 44" sweep antique wide  
 oval woven bamboo



**SOLD SEPARATELY:**



additional blade options: p.149-150  
 control options: p.141-146  
 light options: p.139-140





**B5213WA**  
 walnut

# CARUSO™

❖ **FAN: FP7000OB** (1)  
oil-rubbed bronze  
assembly  
**BLADES: B5213WA** (1)  
52" sweep walnut  
carved wood

oil-rubbed  
bronze  
**FP7000OB**

  
**MIX & MATCH**  
components  
sold separately

  
**3-SPEED AC**  
reverse switch  
on fans

  
**CONTROL**  
wall

  
**DRY OR DAMP**  
model specific

INCLUDED:



CW3WH-CA wall control

**LIMITED LIFETIME MOTOR WARRANTY**



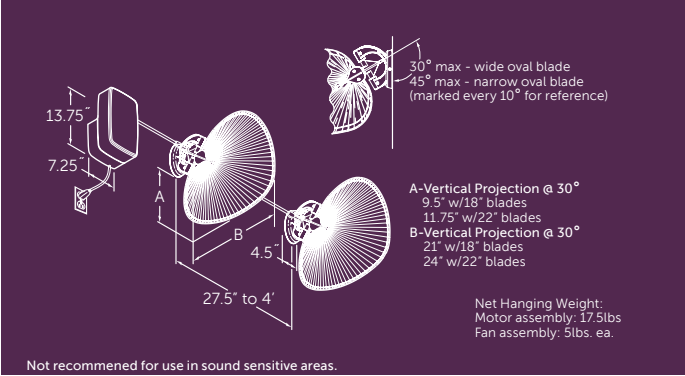

**MOTOR: FP780AB** (1)  
antique brass assembly  
**FAN ASSEMBLIES: FP720AB** (4)  
antique brass  
**BLADES: PUP1** (4)  
22" natural palm leaf wide oval



**MOTOR: FP780PW** (1)  
pewter assembly  
**FAN ASSEMBLIES: FP720PW** (6)  
pewter  
**BLADES: PUD1A** (6)  
22" antique woven bamboo wide oval



**MOTOR: FP780RS** (1)  
rust assembly  
**FAN ASSEMBLIES: FP720RS** (4)  
rust  
**BLADES: PUD1A** (4)  
22" antique woven bamboo wide oval



**SOLD SEPARATELY:**



See page 149-150 for blade options

# PUNKAH®

 **MOTOR: FP780PW** (1)  
 pewter assembly  
**FAN ASSEMBLIES: FP720PW** (5)  
 pewter  
**BLADES: PUP1** (5)  
 22" natural palm leaf wide oval

antique  
 brass  
**FP780AB**  
**FP720AB**

pewter  
**FP780PW**  
**FP720PW**

rust  
**FP780RS**  
**FP720RS**

  
**POWER CORD**  
 2' cord

  
**MIX & MATCH**  
 components  
 sold separately

  
**1-SPEED AC**  
 no reverse

  
**DRY OR DAMP**  
 model specific

LIMITED LIFETIME MOTOR WARRANTY



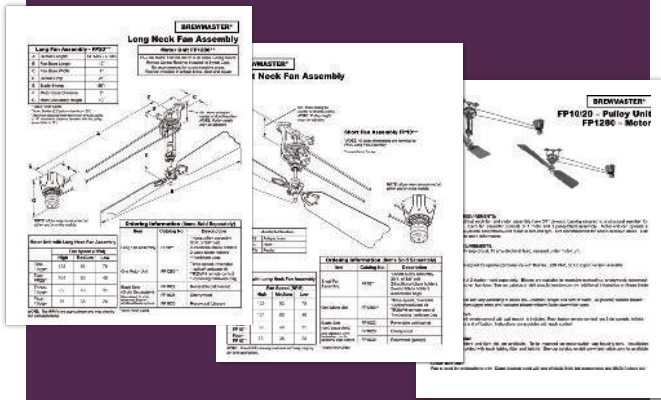

The Brewmaster® carries on Fanimation's reputation for reproducing unusual, yet function, belt-drive fans. These fans were originally produced in the late 1800s by Snediker & Carr®, the premier belt-drive fan manufacturer of their day. Fanimation has adapted this timeless masterpiece to install and operate with more ease and durability.

- Neoprene belting replaces the high-maintenance leather belts.
- Lead and copper babbitt sleeves have given way to sealed ball bearings.
- Hardwood laminate blades that resist warping and splitting replace the temperamental solid wood blades.

The Brewmaster® combines the latest technology with several blade options including the original oversized wood blade design. The Brewmaster® is powered by a gearless direct drive motor, and allows you to operate one or two fans.

For dimensions and configurations, please see our comprehensive Specification Book or model-specific specification sheet, available at [fanimation.com](http://fanimation.com)

Not recommended for use in sound sensitive areas.

- ❖ **MOTOR: FP1280AB** (1)  
antique brass assembly
- HEAD: FP10AB** (2)  
antique brass short neck assembly
- BLADE SET: BMP1** (2)  
50" sweep natural finish wide oval palm

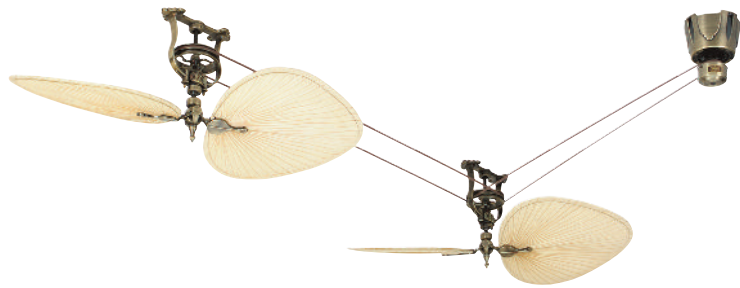

- ☉ **MOTOR: FP1280BL** (1)  
black assembly (required but not shown)
- HEAD: FP20BL** (1)  
black long neck assembly
- BLADE SET: BMD4A** (1)  
50" sweep narrow oval woven bamboo

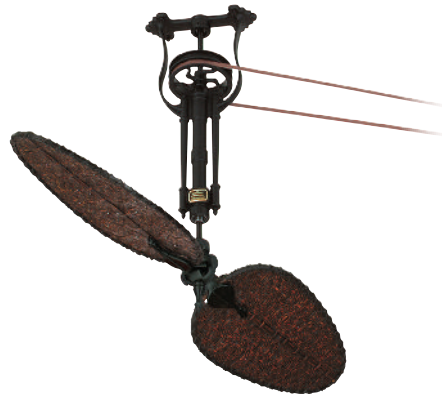

- ❖ **MOTOR: FP1280PW** (1)  
pewter assembly (required but not shown)
- HEAD: FP10PW** (1)  
pewter short neck assembly
- BLADE SET: FP1030** (1)  
26" sweep rosewood



**SOLD SEPARATELY:**



additional blade options: p.149-150  
control options: p.141-146  
light options: p.139-140



reversible oak/walnut

**FP1022**  
wood ❖



cherry

**FP1026**  
wood ❖



rosewood

**FP1030**  
wood ❖



# BREWMASTER™

- ◆ **MOTOR: FP1280BL** (1)  
black assembly (required but not shown)
- ◆ **HEAD: FP20BL** (1)  
black long neck assembly
- ◆ **BLADE SET: FP1026** (1)  
25" cherry

antique  
brass

**FP1280AB**  
**FP10AB**  
**FP20AB**

black

**FP1280BL**  
**FP10BL**  
**FP20BL**

pewter

**FP1280PW**  
**FP10PW**  
**FP20PW**

INCLUDED:



TR20WH control



**MIX & MATCH**  
components  
sold separately



**3-SPEED AC**  
reverse switch  
on remote



**CONTROL**  
remote



**DRY OR DAMP**  
model specific

FAN SPEED (RPM): Fan Assemblies

	High	Medium	Low
<b>One</b>	<b>127</b>	<b>100</b>	<b>82</b>
<b>Two</b>	<b>106</b>	<b>60</b>	<b>46</b>
<b>Three</b>	<b>89</b>	<b>46</b>	<b>35</b>
<b>Four</b>	<b>76</b>	<b>38</b>	<b>28</b>

LIMITED LIFETIME MOTOR WARRANTY







PORTABLES



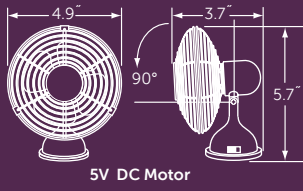

Net Weight: 1.1 lbs.

**FAN: FP6252BN (1)**  
brushed nickel assembly with  
brushed nickel fan blades and  
brushed nickel cage



**FAN: FP6252BN (1)**  
brushed nickel assembly with  
brushed nickel fan blades and  
brushed nickel cage



**FAN: FP6252BN (1)**  
brushed nickel assembly with  
brushed nickel fan blades and  
brushed nickel cage



# MINI BREEZE™



 **FAN: FP6252BN (1)**  
brushed nickel assembly with  
brushed nickel blades and  
brushed nickel cage

brushed nickel  
brushed nickel  
**FP6252BN**

  
**USB PLUG**

  
**1-SPEED**  
no reverse

  
**DRY**  
indoor only

**INCLUDED:**



USB power cord

**LIMITED LIFETIME MOTOR WARRANTY**

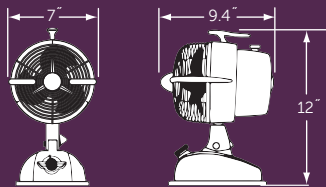

76 x 66 AC Motor

Net Weight: 5.1 lbs.

**FAN: FP7958BB (1)**  
baby blue assembly with chrome accents and black blades



**FAN: FP7958MB (1)**  
mysterious black assembly with chrome accents and black blades



**FAN: FP7958MI (1)**  
milky ivory assembly with chrome accents and black blades



**FAN: FP7958SR (1)**  
spicy red assembly with chrome accents and black blades



**FAN: FP7958SS (1)**  
sonic silver assembly with chrome accents and black blades





# URBANJET™



 **FAN: FP7958SS (1)**  
sonic silver assembly with  
chrome accents and black blades

baby blue FP7958BB	mysterious black FP7958MB	milky ivory FP7958MI	spicy red FP7958SR	sonic silver FP7958SS
-----------------------	------------------------------	-------------------------	-----------------------	--------------------------



**3-SPEED**  
no reverse



**POWER CORD**  
5.5' cord



**CONTROL**  
rotary



**DRY**  
indoor only

**LIMITED LIFETIME MOTOR WARRANTY**

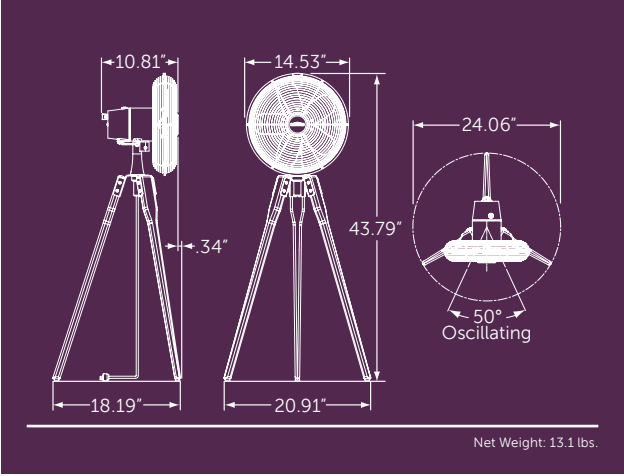

**FAN: FP8014OB (1)**  
oil-rubbed bronze assembly with black blades and walnut legs



**FAN: FP8014SN (1)**  
satin nickel assembly with black blades and walnut legs







# ARDEN™



**FAN: FP8014SN (1)**  
satin nickel assembly with  
black blades and walnut legs

oil-rubbed bronze	satin nickel
walnut	walnut
<b>FP8014OB</b>	<b>FP8014SN</b>



**3-SPEED**  
no reverse



**POWER CORD**  
8' cord



**CONTROL**  
rotary



**DRY**  
indoor only

**LIMITED LIFETIME MOTOR WARRANTY**

For dimensions and configurations, please see our comprehensive Specification Book or model-specific specification sheet, available at [fanimation.com](http://fanimation.com)

**FAN: FPH210AC** (1)  
antique copper with black motor assembly  
**CEILING MOUNT: FPH81BL1** (1)  
black ceiling mount—1" dia. x 6" long downrod included



**FAN: FPH210BL** (1)  
black assembly  
**BASE: FPH21BL** (1)  
black floor base  
**COLUMN: FPH70CP** (1)  
carved post column



**FAN: FPH210RS** (1)  
rust assembly  
**WALL MOUNT: FPH61RS** (1)  
rust wall mount



**SOLD SEPARATELY:**

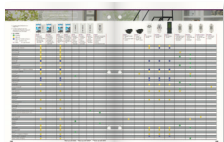

See page 141-146 for additional controls

**COLUMNS**



BL—black

CP—carved post

**FPH70\*\***

**PEDESTAL MOUNT**



**FPH21BL**  
black

**WALL MOUNT**



**FPH61\*\***  
black or rust

**CEILING MOUNT**



**FPH81\*\*1**  
black or rust

use with CW1WH



**CW1WH**  
wall control

# OLD HAVANA™



 **MOTOR: FPH210RS** (1)  
 rust assembly  
**BASE: FPH21BL** (1)  
 black pedestal base  
**COLUMN: FPH70CP** (1)  
 carved post

antique copper	black	rust
black	black	rust
<b>FPH210AC</b>	<b>FPH210BL</b>	<b>FPH210RS</b>

  
**MIX & MATCH**  
 components  
 sold separately

  
**3-SPEED**  
 no reverse

  
**POWER CORD**  
 8' cord

  
**CONTROL**  
 rotary

  
**DRY OR DAMP**  
 model specific

LIMITED LIFETIME MOTOR WARRANTY



## LIGHT KITS

- Light kits are for use with most Fanimation fans
- Light bulb requirements vary and are listed for each light kit
- Pull-chain light kits come with chain and fob
- Light bulbs included
- **UL LISTED**



- ◊ **LK112A** antique bamboo with white frosted glass
- 6" (H) x 10" (W)
  - One 60W candelabra bulbs included



- ◊ **LK122A** antique bamboo with white frosted glass
- 8" (H) x 13" (W)
  - Three 40W candelabra bulbs included



- ◊ **LK250** white frosted 13" bowl light kit
- 8" (H) x 13" (W)
  - Three 50W halogen minican bulbs included



- ◊ **LK260** amber frosted 13" bowl light kit
- 8" (H) x 13" (W)
  - Three 50W halogen minican bulbs included



- ✦ **LK113WH** white fabric drum lamp shade
- 6.9" (H) x 14" (W)
  - Three 50W halogen minican bulbs included



- ◊ **LK114AOB** oil-rubbed bronze
- low-profile light kit
  - opal frosted glass
  - pull chain operation
  - 4.8" (H) x 14" (W)
  - One 100W halogen minican bulb included



- ✦ **LK124ABA** bronze accent  
◊ **LK124ATS** tortoise shell
- low-profile light kit
  - opal frosted glass
  - pull chain operated
  - 4.8" (H) x 12" (W)
  - One 100W halogen minican bulb included



- ◊ **LK124WTS** tortoise shell
- low-profile light kit
  - opal frosted glass
  - pull chain operated
  - 4.8" (H) x 12" (W)
  - One 100W halogen minican bulb included



- ◊ **LKLP101OB** oil-rubbed bronze  
◊ **LKLP101SN** satin nickel
- low-profile light kit
  - opal frosted glass
  - pull chain operation
  - 8.5" (H) x 5.2" (W)
  - One 100W halogen minican bulb included



- ◊ **LKLP102OB** oil-rubbed bronze  
◊ **LKLP102SN** satin nickel
- low-profile light kit
  - opal frosted glass
  - pull chain operation
  - 8" (H) x 5.2" (W)
  - One 100W halogen minican bulb included



- ◊ **LKLP111AOB** oil-rubbed bronze
- low-profile light kit
  - amber linen glass
  - pull chain operation
  - 8.5" (H) x 5.2" (W)
  - One 100W halogen minican bulb included



- ◊ **LKLP111WWH** oil-rubbed bronze
- low-profile light kit
  - white linen glass
  - pull chain operation
  - 8.5" (H) x 5.2" (W)
  - One 100W halogen minican bulb included



- ◊ **LKLP112AOB** oil-rubbed bronze
- low-profile light kit
  - amber linen glass
  - pull chain operation
  - 8.5" (H) x 5.2" (W)
  - One 100W halogen minican bulb included



- ◊ **LKLP112WSN** satin nickel
- low-profile light kit
  - white linen glass
  - pull chain operation
  - 8.5" (H) x 5.2" (W)
  - One 100W halogen minican bulb included

# FITTERS, SHADES & DECORATIVE GLASS

- Bowl fitters are for use with most Fanimation fans
- Fitter glass sold separately below
- Glass bowls—12.75" diameter x 4.75" height (G210 and G400 series) require fitters F423 and FW423
- Small glass and shades (G200 series) for use with myFanimation F4 fitter only—page 71
- Finishes and light bulb requirements vary and are listed for each
- Glass and shades should be ordered based on the fitter model selected
- Light bulbs included

**UL LISTED**



- ◆ F423AB antique brass
- F423BA bronze accent
- F423AZ aged bronze
- F423MW matte white
- F423OB oil-rubbed bronze
- ◆ F423PW pewter
- F423RS rust
- F423SN satin nickel
- F423TS tortoise shell
- F423VZ venetian bronze
- F423WH white

- ◆ FW423AZ aged bronze
- ◆ FW423OB oil-rubbed bronze
- ◆ FW423RS shown in rust
- ◆ FW423TS tortoise shell
- ◆ FW423WH white

- Uses glass bowls only, sold separately (page 127)
- 7 (H) x 13" (W)
- Three 60W candelabra bulbs included

- 6" (H) x 6" (W)
- Three 50W halogen minican bulbs included



**G210**  
Tropical bowl



**G439**  
Hand-painted parrot



**G450**  
Amber



**G451**  
Powdered amber



**G456**  
White frost

## ADDITIONAL myFANIMATION GLASS



**G100C**  
Clear ribbed



**G100F**  
White frosted ribbed



**G235**  
Tropical etched glass



**G239**  
Hand-painted parrot



**G244**  
Aged bronze/amber shade



**G250**  
Amber



**G256**  
White frost

# REMOTE CONTROLS

- Control specifications on page 145
- Control options are not available for Bourbon Street®, Palmetto® and Punkah®

## UL LISTED

- Ⓢ Included
  - Ⓞ Optional
  - Ⓞ Optional—Install control in a dry location only
- WH—White LA—Light Almond



- |   |  |  |   |   |  |   |   |
|---|--|--|---|---|--|---|---|
| <b>BTCR9</b>  | <b>BTCR9U</b>  | <b>BTR9</b>  | <b>BTR9U</b>  | <b>BTT9</b>   | <b>BTT9U</b>   | <b>BTT9R</b>  | <b>TR205</b>  |
| • Bluetooth® connectivity<br>• Fan and downlight<br>• Receiver unit and hand-held transmitter | • Bluetooth® connectivity<br>• Fan and up/downlight<br>• Receiver unit and hand-held transmitter | • Bluetooth® connectivity<br>• Fan and downlight<br>• Receiver unit only | • Bluetooth® connectivity<br>• Fan and up/downlight<br>• Receiver unit only | • fanSync™ hand-held remote<br>• Non-reversing<br>• Fan and downlight | • fanSync™ hand-held remote<br>• Non-reversing<br>• Fan and up/downlight | • fanSync™ hand-held remote<br>• Reversing<br>• Fan and downlight | • Hand-held remote<br>• Fan and downlight<br>• Shutoff timer<br>• Home away<br>• Fresh air<br>• Safe exit |

Aire Décor®—BP200/210/215/220/225	Ⓞ		Ⓞ				
Aire Décor®—BP230	Ⓞ		Ⓞ				
Aire Deluxe	Ⓞ		Ⓞ				
Americana®	Ⓞ		Ⓞ				
Ascension™	Ⓞ		Ⓞ				
Avaston™	Ⓞ		Ⓞ	Ⓞ			
Beckwith™	Ⓞ		Ⓞ	Ⓞ			
Belleria®	Ⓞ		Ⓞ				
Benito™	Ⓞ		Ⓞ	Ⓞ			
Brewmaster®							
Camhaven™	Ⓞ		Ⓞ	Ⓞ			
Cancun™ (WET)—FP8012 & FP8016	Ⓞ		Ⓞ				
Cancun™—FP8042	Ⓞ		Ⓞ				
Caruso™							
Celano V2™				Ⓢ			
Crestford™	Ⓞ		Ⓞ				
Edgewood®	Ⓞ		Ⓞ				
Embrace™							
Enigma®	Ⓞ		Ⓞ	Ⓞ			
Extraordinaire®							
Inlet™	Ⓞ		Ⓞ				
Islander® AC	Ⓞ		Ⓞ				
Islander® DC							
Jennix™							
Keystone™							
Levon™	Ⓞ		Ⓞ				
Levon™ Custom							
Levon™ DC							
Louvre®							
Marea™	Ⓞ		Ⓞ	Ⓞ			
myFanimation™ Distinction™—A1/C1						Ⓢ	
myFanimation™ Distinction™—D1							Ⓢ
Odyn™							
Old Havana®							
Palisade®							
Spitfire™				Ⓢ			
Subtle™							Ⓢ
Torto™	Ⓞ		Ⓞ			Ⓞ	
Torto™ LED						Ⓢ	
Ventana™	Ⓞ		Ⓞ				
Windpointe®	Ⓞ		Ⓞ				
Xeno™				Ⓢ			
Zonix™—FP4620 & FP4630	Ⓞ		Ⓞ				
Zonix™ (WET)—FP4640	Ⓞ		Ⓞ				
Zonix™ (LED)—FP4650	Ⓞ		Ⓞ	Ⓞ			

\*Must use with SW24 \*\*Must use with SW50\*\* \*\*\* Must use with SW70



# WALL CONTROLS

- Wall controls include matching face plate
- Control specifications on page 145
- Control options are not available for Bourbon Street®, Palmetto® and Punkah®

**• UL LISTED**

- Ⓢ Included
  - Ⓢ Optional
  - Ⓢ Optional—Install control in a dry location only
- WH—White      LA—Light Almond



**CW1WH & CW1LA**  
• Fan-only slide control



**CW1SWWH & CW1SWLA**  
• Fan slide control with light toggle switch



**CW2WH & CW2LA**  
• Fan and light slide control



**CW3WH**  
• Fan-only slide control  
• CW3\*+CA for Caruso™



**CW5WH & CW5LA**  
• Two-fan slide control



**CW6WH**  
• Palisade® fan and light slide control

Aire Décor®—BP200/210/215/220/225	<span style="color: yellow;">Ⓢ</span>	<span style="color: yellow;">Ⓢ</span>	<span style="color: yellow;">Ⓢ</span>		<span style="color: yellow;">Ⓢ</span>	
Aire Décor®—BP230	<span style="color: blue;">Ⓢ</span>	<span style="color: blue;">Ⓢ</span>	<span style="color: blue;">Ⓢ</span>		<span style="color: blue;">Ⓢ</span>	
Aire Deluxe	<span style="color: yellow;">Ⓢ</span>		<span style="color: yellow;">Ⓢ</span>		<span style="color: yellow;">Ⓢ</span>	
Americana®	<span style="color: yellow;">Ⓢ</span>	<span style="color: yellow;">Ⓢ</span>	<span style="color: yellow;">Ⓢ</span>		<span style="color: yellow;">Ⓢ</span>	
Ascension™						
Avaston™						
Beckwith™						
Belleria®	<span style="color: blue;">Ⓢ</span>	<span style="color: blue;">Ⓢ</span>	<span style="color: blue;">Ⓢ</span>		<span style="color: blue;">Ⓢ</span>	
Benito™						
Brewmaster®						
Camhaven™						
Cancun™ (WET)—FP8012 & FP8016	<span style="color: blue;">Ⓢ</span>	<span style="color: blue;">Ⓢ</span>	<span style="color: blue;">Ⓢ</span>		<span style="color: blue;">Ⓢ</span>	
Cancun™—FP8042	<span style="color: yellow;">Ⓢ</span>	<span style="color: yellow;">Ⓢ</span>	<span style="color: yellow;">Ⓢ</span>		<span style="color: yellow;">Ⓢ</span>	
Caruso™				<span style="color: green;">Ⓢ</span>		<span style="color: yellow;">Ⓢ</span>
Celano V2™						
Crestford™	<span style="color: blue;">Ⓢ</span>	<span style="color: blue;">Ⓢ</span>	<span style="color: blue;">Ⓢ</span>		<span style="color: blue;">Ⓢ</span>	
Edgewood®	<span style="color: blue;">Ⓢ</span>	<span style="color: blue;">Ⓢ</span>	<span style="color: blue;">Ⓢ</span>		<span style="color: blue;">Ⓢ</span>	
Embrace™						
Enigma®						
Extraordinaire®						
Inlet™						
Islander® AC	<span style="color: yellow;">Ⓢ</span>	<span style="color: yellow;">Ⓢ</span>	<span style="color: yellow;">Ⓢ</span>		<span style="color: yellow;">Ⓢ</span>	
Islander® DC						
Jennix™						
Keystone™						
Levon™	<span style="color: yellow;">Ⓢ</span>	<span style="color: yellow;">Ⓢ</span>	<span style="color: yellow;">Ⓢ</span>		<span style="color: yellow;">Ⓢ</span>	
Levon™ Custom						
Levon™ DC						
Louvre®						
myFanimation™ Distinction™—A1/C1						
myFanimation™ Distinction™—D1						
Marea™						
Odyn™						
Old Havana®						
Palisade®				<span style="color: green;">Ⓢ</span>		<span style="color: yellow;">Ⓢ</span>
Spitfire™						
Subtle™						
Torto™						
Torto™ LED						
Ventana™						
Windpointe®	<span style="color: yellow;">Ⓢ</span>	<span style="color: yellow;">Ⓢ</span>	<span style="color: yellow;">Ⓢ</span>		<span style="color: yellow;">Ⓢ</span>	
Xeno™						
Zonix™—FP4620 & FP4630		<span style="color: yellow;">Ⓢ</span>	<span style="color: yellow;">Ⓢ</span>		<span style="color: yellow;">Ⓢ</span>	
Zonix™ (WET)—FP4640	<span style="color: blue;">Ⓢ</span>	<span style="color: blue;">Ⓢ</span>	<span style="color: blue;">Ⓢ</span>		<span style="color: blue;">Ⓢ</span>	
Zonix™ (LED)—FP4650						

\*Must use with SW50\*\*





# CONTROL SPECIFICATIONS



WH—White



LA—Light Almond



**CW1WH & CW1LA**

- Fan-only slide control
- 2-wire installation
- 3 fan speeds
- 1.25 amps max. fan load



**CW1SWWH & CW1SWLA**

- Fan slide control with light on/off toggle switch
- 3-wire installation
- 3 fan speeds
- 1.25 amps max. fan load



**CW2WH & CW2LA**

- Fan and light slide control
- 3-position light levels
- 3-wire installation
- 3 fan speeds
- 1.25 amps max. fan load



**CW3WH**

- Palisade® and Caruso™ fan-only slide control
- CW3\*\*CA for Caruso™
- 2-wire installation
- 2 fan speeds
- 5 amps max. fan load



**CW5WH & CW5LA**

- Fan-only two fan slide control
- 2-wire installation
- 3 fan speeds
- 5 amps max. fan load



**CW6WH**

- Palisade® fan and light control
- 3-position light levels
- 3-wire installation
- 2 fan speeds



**C21**

- Reversible fan and light control
- 2-wire installation
- 3 fan speeds
- infinite light levels



**C23**

- Reversible fan and light control
- 2-wire installation
- 3 fan speeds
- infinite light levels for uplight and downlight



**C25**

- Non-reversing fan and light control
- battery operated
- 3 fan speeds
- infinite light levels



**CW40**

- Fan-only slide control
- 2-wire installation
- 4 fan speeds
- 1.25 amps max. fan load



**CW110WH**

- Extraordinaire® fan-only slide control
- 2-wire installation
- 3 fan speeds
- 1.25 amps max. fan load



**CW60WH**

- Fan and light control
- 3-wire installation
- 3-position light levels
- 3 fan speeds
- 1.25 amps max. fan load
- Wet rated when used with WP60—this page



**TR20WH**

- Reversible fan and light remote
- mounts over switch plate
- 3 fan speeds
- Downlight control



**TR22WH**

- Reversible fan and light remote
- mounts over switch plate
- 3 fan speeds
- Uplight and downlight control



**TR24WH**

- Non-reversible fan and light remote
- mounts over switch plate
- 3 fan speeds
- Downlight control



**TR39**

- DC reversible fan and light remote
- Learn-mode for easy set up and 65,000 code settings
- 6 fan speeds
- Downlight control



**TR41**

- DC reversible fan and light remote
- Learn-mode for easy set up and 65,000 code settings
- 6 fan speeds
- Uplight and downlight control



**TW40WH & TW40LA**

- DC reversible fan and light wall control
- Learn-mode for easy set up and 65,000 code settings
- Includes switch plate
- 6 fan speeds
- Downlight control



**TR205**

- DC reversible fan and light remote
- mounts over switch plate
- 31 fan speeds
- Downlight control
- 1, 3 and 6 hour timer
- Fresh Air function
- Safe Exit function
- Home Away function



**TW206**

- DC reversible fan and light control
- mounts over switch plate
- 31 fan speeds
- Downlight control
- 1, 3 and 6 hour timer
- Fresh Air function
- Safe Exit function
- Home Away function



**TR33WH**

- Marea™ fan remote
- mounts over switch plate
- 3 fan speeds



**C4**

- Non-reversing fan and light remote
- Learn-mode canopy receiver unit for easy set up and 65,000 code settings included
- 3 fan speeds
- 1.25 amps max. fan load
- Infinite light levels up to 250 watts



**CRL4WH**

- Non-reversing fan and light remote
- Learn-mode canopy receiver unit for easy set up and 65,000 code settings included
- 3 fan speeds
- 1.25 amps max. fan load
- Infinite light levels up to 190 watts
- Dimmer on/off switch for use with CFL bulbs (dimmer must be turned off)
- May be used with CWRL4\*\*



**CWRL4WH & CWRL4LA**

- Non-reversing fan and light control
- 2-wire installation
- 3 fan speeds
- 1.0 amps max. fan load
- Learn-mode canopy receiver unit for easy set up and 65,000 code settings included
- Infinite light levels up to 190 watts
- Dimmer on/off switch for use with CFL bulbs (dimmer must be turned off)
- May be used with CRL4WH



**CRL8TS**

- Non-reversing touch-screen fan and light remote
- Learn-mode canopy receiver unit for easy set up and 65,000 code settings included
- 3 fan speeds
- Fan timer delay feature
- Delay light feature
- 1.0 amps max. fan load
- Infinite light levels up to 190 watts
- Dimmer on/off switch for use with CFL bulbs (dimmer must be turned off)



**CH1WH & CH1LA**

- Old Havana® fan remote
- mounts over switch plate
- 3 fan speeds



**RC110WH**

- Extraordinaire® non-reversing fan remote
- mounts over switch plate
- 3 fan speeds



**WP60**

- Outdoor control box
- Designed for use with CW60 wall control.
- Fits decora style controls
- Includes gasket.
- 5.3" (L) x 3.9" (W) x 4.8" (H)

# CONTROL ACCESSORY



CONTROL YOUR CEILING FAN WITH YOUR SMART DEVICES!



**BTCR9**

- fanSync™ Bluetooth® receiver & companion remote control
- 3 fan speeds
- Downlight control
- Timer, safe exit and favorites list via smart device
- Wall mount for remote

**BTCR9U**

- fanSync™ Bluetooth® receiver & companion remote control
- 3 fan speeds
- Up & downlight control
- Timer, safe exit and favorites list via smart device
- Wall mount for remote

**BTT9**

- fanSync™ companion remote control
- 3 fan speeds
- Downlight control
- Wall mount for remote

**BTT9R**

- fanSync™ companion remote control
- 3 fan speeds with reverse
- Downlight control
- Wall mount for remote

**BTT9U**

- fanSync™ companion remote control
- 3 fan speeds
- Up & downlight control
- Wall mount for remote

**BTR9**

- fanSync™ Bluetooth® receiver
- Controls fan and light via smart device
- 3 fan speeds
- Downlight control
- Timer, safe exit and favorites list via smart device
- Wall mount for remote

**BTR9U**

- fanSync™ Bluetooth® receiver
- Controls fan and light via smart device
- 3 fan speeds
- Up & downlight control
- Timer, safe exit and favorites list via smart device
- Wall mount for remote

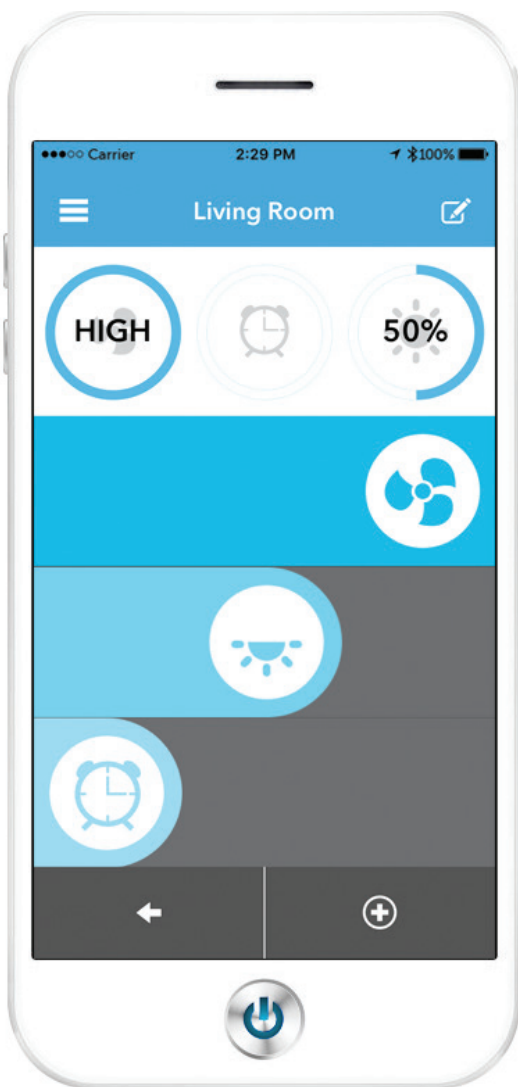

1 Visit [www.fanimation.com/fansync](http://www.fanimation.com/fansync) to check your fan and device compatibility. fanSync is universal and works with most brands of **3-speed AC ceiling fans**.

2 Easily wire and install the fanSync receiver into your ceiling fan's hanger bracket/canopy.

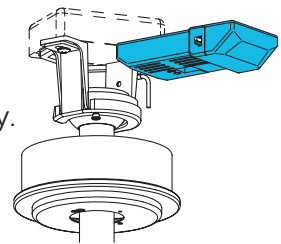

3 Download the fanSync app to your smart device from Google Play or the App Store.

4 Easily find and set up your fan(s) in the fanSync app.

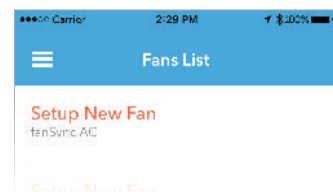

5 Explore and enjoy the many features of the fanSync app!



Fan Speed



Light Dimming



Timer



Safe Exit



Favorites List

# DOWNRODS & ACCESSORIES

## DOWNRODS

- Order according to length
- Use finish code to complete the part number
- See page 3 for suggested lengths

<b>STEEL</b>	*DR1-6OB	6" downrod	DR1-36**	36" downrod
	DR1-12**	12" downrod	DR1-48**	48" downrod
	DR1-18**	18" downrod	DR1-60**	60" downrod
	DR1-24**	24" downrod	DR1-72**	72" downrod

antique brass AB	aged bronze AZ	bronze accent BA	black BL	brushed nickel BN
brushed satin brass BS	dark copper penny DCP	driftwood DF	dark bronze DZ	matte greige GR
metro gray MG	matte white MW	oil-rubbed bronze OB	polished nickel PN	pewter PW
rust RS	satin nickel SN	textured black TB	tortoise shell TS	white WH

<b>STAINLESS STEEL</b>	DR1-12***	12" wet downrod	DR1-48***	48" wet downrod
	DR1-18***	18" wet downrod	DR1-60***	60" wet downrod
	DR1-24***	24" wet downrod	DR1-72***	72" wet downrod
	DR1-36***	36" wet downrod		

**TRUE STAINLESS STEEL DOWNROD.**  
Wet location rated. Resistant to rust and corrosion.

black wet BLW	brushed nickel wet BNW	dark bronze wet DZW	matte greige wet GRW	matte white wet MWW
oil-rubbed bronze wet OBW	satin nickel wet SNW	white wet WHW		

## DOWNROD COUPLERS



- Joins two downrods together for extended lengths
- When ordering, use finish code for steel downrods shown above to complete the part number.

DR1-CP\*\* 1" diameter downrod coupler

## CLOSE-TO-CEILING KIT



- Replaces hanger bracket/downrod assembly to move your fan closer to the ceiling, creating more head room
- Intended for use with low ceilings.
- Please see individual fan pages for compatibility
- Tall dimensions: 5.13" (H) x 8" (DIA.)
- Short dimensions: 2.67" (H) x 8" (DIA.)

## STANDARD

CCK8002AB	antique brass	CCK8002MW	matte white
CCK8002AZ	aged bronze	CCK8002OB	oil-rubbed bronze
CCK8002BA	bronze accent	CCK8002PN	polished nickel
CCK8002BL	black	CCK8002PW	pewter
CCK8002BN	brushed nickel	CCK8002RS	rust
CCK8002CH	chrome	CCK8002SN	satin nickel
CCK8002DCP	dark copper penny	CCK8002TS	tortoise shell
CCK8002DZ	dark bronze	CCK8002WH	white

## SLOPED CEILING BALL KIT



- Includes black hanger ball only
  - For use with Fanimation fans purchased after June 2004
  - See individual fan pages for compatibility with your fan
  - Hanger ball works with current Fanimation canopy and hanger bracket
  - Allows for ceiling slope up to 42°
  - For use with any length downrod
- SCB1-52 For use with 1" dia. downrods

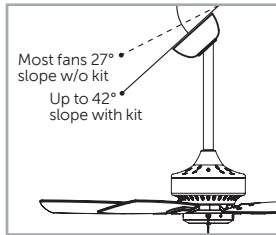

## SLOPED CEILING KIT



- Includes hanger bracket, hanger ball, ceiling canopy, canopy screw cover and mounting hardware
- For use with Aire Décor®, Benito™ and Edgewood® series fans
- Allows for ceiling slope up to 42°
- For use with any length downrod

SCK1-52AZ	aged bronze	SCK1-52PN	polished nickel
SCK1-52BL	black	SCK1-52PW	pewter
SCK1-52BN	brushed nickel	SCK1-52SN	satin nickel
SCK1-52MW	matte white	SCK1-52TS	tortoise shell
SCK1-52OB	oil-rubbed bronze	SCK1-52WH	white

## WET RATED

CCK8002BLW	black wet	CCK8002MWW	matte white wet
CCK8002BNW	brushed nickel wet	CCK8002OBW	oil-rubbed bronze wet
CCK8002DZW	dark bronze wet	CCK8002SNW	satin nickel wet
CCK8002GRW	matte greige wet	CCK8002WHW	white wet

## EXTENSION POLES

- For use with Palisade® only
- Order according to length
- Use finish code to complete the part number

EP24**	24" downrod
EP30**	30" downrod
EP36**	36" downrod
EP48**	48" downrod
EP60**	60" downrod
EP72**	72" downrod

## EXTENSION POLE COUPLERS



- For use with Palisade® only
- Joins two extension poles together for extended lengths
- Use finish code to complete the part number.

EPCC\*\* Extension pole coupler

## DOWNROD SLEEVE



- Tropical downrod sleeve
- 16" tall
- Requires minimum 24" downrod or extension pole

DRS24TR Downrod sleeve

## BULB REFERENCE



- Fans that include a light kit list the light source under the light kit feature icon on the fan page
- Understanding lumens, correlated color temperature and color rendering index values will help you understand what light output to expect from each fan

### LUMENS VERSUS WATTS

In years past, consumers used wattage to rate the brightness of a lamp. However, wattage is a measure of energy use and is not an accurate indicator of lamp brightness. Energy efficient light sources such as LEDs and Compact Fluorescent Lamps (CFL) have much lower wattages while still producing a great amount of light. While wattage measures energy use, lumens measure light output—luminous flux. When determining light output, it is best to compare lumens.

### WHAT IS CORRELATED COLOR TEMPERATURE?

Color appearance, also known as Correlated Color Temperature (CCT), is a measure of how warm or cool a light source appears to the human eye. It is measured in degrees Kelvin. The majority of light sources have a Kelvin temperature within the range of 2700K to 6500K. For reference, noon-time daylight has a Kelvin temperature of 5000K. Incandescent light sources generally range from 2700-3500K. Compact Fluorescents and LEDs can range from 2700-6500K. The lower the Kelvin temperature, the warmer the light source appears and the higher the Kelvin temperature, the cooler the light source appears.

WARM WHITE	2700K
SOFT WHITE	3000K
NEUTRAL	3500K
COOL	4100K
SOFT DAYLIGHT	5000K
DAYLIGHT	6500K

### WHAT IS THE COLOR RENDERING INDEX?

CRI is the ability of a light source to light up objects of different colors and properly display the colors without influence or making the color look adjusted. CRI is represented by a number on a scale from 0 to 100 with 100 being best. The lower the number, the more distorted a color will look under the light source.

### EXAMPLES OF BULB BASES AND TYPES

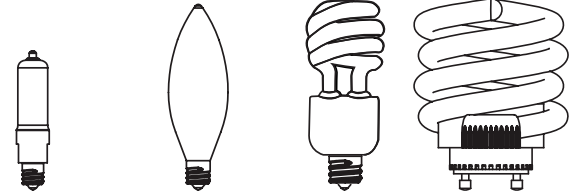

E11 Minican    E12 Candelabra    E26 CFL    GU24 CFL

Bulb Base	Bulb Type	Watts	Lumens per Bulb	Correlated Color Temperature (CCT)	Color Rendering Index (CRI)
E11	Minican Halogen Frosted	50	500	2800	100
E11	Minican Halogen Frosted	75	1000	2800	100
E11	Minican Halogen Clear	100	1400	2800	100
E12	Candelabra Incandescent Frosted	40	340	2800	100
E12	Candelabra Incandescent Clear	40	358	2800	100
E12	Candelabra Halogen (B10)	43	750	2800	100
E12	Candelabra Incandescent Frosted	60	510	2800	100
E12	Candelabra Incandescent Clear	60	610	2800	100
E26	Compact Fluorescent (CFL)	13	959	2700	80
E26	Compact Fluorescent (CFL)	23	1600	2700	80
GU24	Compact Fluorescent (CFL)	13	900	2700	80
GU24	Compact Fluorescent (CFL)—Short Neck	18	1144	2700	80
GU24	Compact Fluorescent (CFL)	18	1250	2700	80
GU24	Compact Fluorescent (CFL)	26	1600	2700	80
Connector Pin	10W LED Module	10	659	2800	80
Connector Pin	16W LED Module	16	1352	3000	80
Connector Pin	18W LED Module	18	1300	3000	80

## BLADES

- Blades listed come in sets of five (5) except those for Punkah®—one (1), Brewmaster®—two (2), Palisade®—eight (8), Palmetto—three (3) and Caruso™—ten (10).
- Blades should be ordered based on the fan model selected
- Blade sets vary based on catalog number and are specific to fan models
- Some blade catalog numbers require fan finish codes
- Due to the nature of the materials and the hand-crafted processes; stain, color, texture and shading will vary



Americana®	ISP1		ISP4	FP1018	B5280WA	B6080WA	B5340WA	
Belleria®	ISP1		ISP4		B5280WA	B6080WA	B5340WA	
Bourbon Street®	ISP1		ISP4	FP1018	B5280WA	B6080WA	B5340WA	
Brewmaster®	BMP1							
Caruso™			CAISP4					
Islander® (AC & DC)	ISP1		ISP4		B5280WA	B6080WA	B5340WA	
Louvre®	ISP1		ISP4		B5280WA	B6080WA	B5340WA	
Palisade®	PAP1							
Palmetto®		PMP2**						
Punkah®	PUP1							
Windpointe® Custom	ISP1		ISP4		B5280WA	B6080WA	B5340WA	



Americana®	ISD1A			ISD4A	BPD1A	BPD4A	BPD4MW	
Belleria®	ISD1A			ISD4A	BPD1A	BPD4A	BPD4MW	
Bourbon Street®	ISD1A			ISD4A	BPD1A	BPD4A	BPD4MW	
Brewmaster®				BMD4A				
Caruso™			CAISD2A	CAISD4A		CABPD4A		
Islander® (AC & DC)	ISD1A			ISD4A	BPD1A	BPD4A	BPD4MW	
Louvre®	ISD1A			ISD4A	BPD1A	BPD4A	BPD4MW	
Palisade®	PAD1A	PAD1C	PAD2A					
Palmetto®			PMD2A**					
Punkah®	PUD1A	PUD1C						
Windpointe® Custom	ISD1A			ISD4A	BPD1A	BPD4A	BPD4MW	

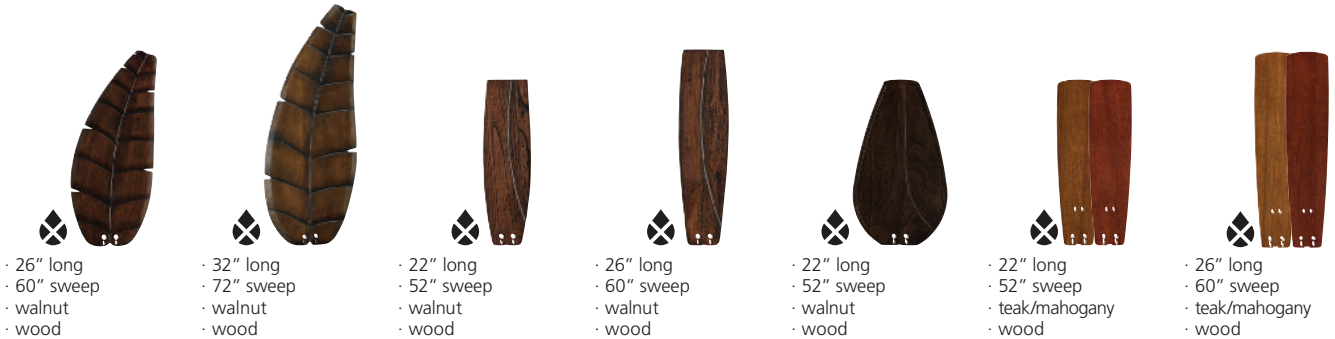
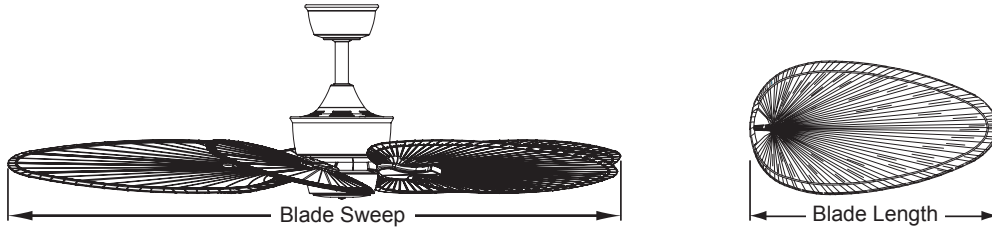

	B5350WA	B5300WA	B5330WA	B6130WA		B5133TKMH	B6133TKMH
	B5350WA	B5300WA	B5330WA	B6130WA		B5133TKMH	B6133TKMH
	B5350WA	B5300WA	B5330WA	B6130WA		B5133TKMH	B6133TKMH
					B5213WA		
	B5350WA	B5300WA	B5330WA	B6130WA		B5133TKMH	B6133TKMH
	B5350WA	B5300WA	B5330WA	B6130WA		B5133TKMH	B6133TKMH
					B5213WA		
	B5350WA	B5300WA	B5330WA	B6130WA		B5133TKMH	B6133TKMH



	BPP1TN	BPP4TN	BPP1BR	BPP4BR	BPW20CY	BPW24MW	BPW6090DNA	BPW6030MH	BPW6030TK
	BPP1TN	BPP4TN	BPP1BR	BPP4BR	BPW20CY	BPW24MW	BPW6090DNA	BPW6030MH	BPW6030TK
	BPP1TN	BPP4TN	BPP1BR	BPP4BR	BPW20CY	BPW24MW	BPW6090DNA	BPW6030MH	BPW6030TK
		CABPP4TN		CABPP4BR					
	BPP1TN	BPP4TN	BPP1BR	BPP4BR	BPW20CY	BPW24MW	BPW6090DNA	BPW6030MH	BPW6030TK
	BPP1TN	BPP4TN	BPP1BR	BPP4BR	BPW20CY	BPW24MW	BPW6090DNA	BPW6030MH	BPW6030TK
	BPP1TN	BPP4TN	BPP1BR	BPP4BR	BPW20CY	BPW24MW	BPW6090DNA	BPW6030MH	BPW6030TK

# ANTIQUe FAN MUSEUM

*presented by the Antique Fan Collectors Association*



## PASSION, HERITAGE & PRESERVATION

Led by our Founder and CEO, Tom Frampton, Fanimation is dedicated to preserving the history of fans and the fan industry. For years, Tom has been an avid antique fan collector and member of the Antique Fan Collectors Association (AFCA). The AFCA membership has operated a museum since 1997, displaying fans on loan by the membership; this museum was in Wichita, Kansas up until 2008, when the need to relocate the museum arose. Answering the call to preserve viewing of the one-of-a-kind collection, Fanimation made the offer to house the museum at its facility in Zionsville. The move and set-up took nearly a year and the museum saw its reopening July 23, 2009. Since that time, the museum has grown and continues to grow, housing over a thousand antique fans on two floors. Tom's own unique collection of fans is a part of the museum collection along with over 500 antique advertising style hand fans and other fan memorabilia.

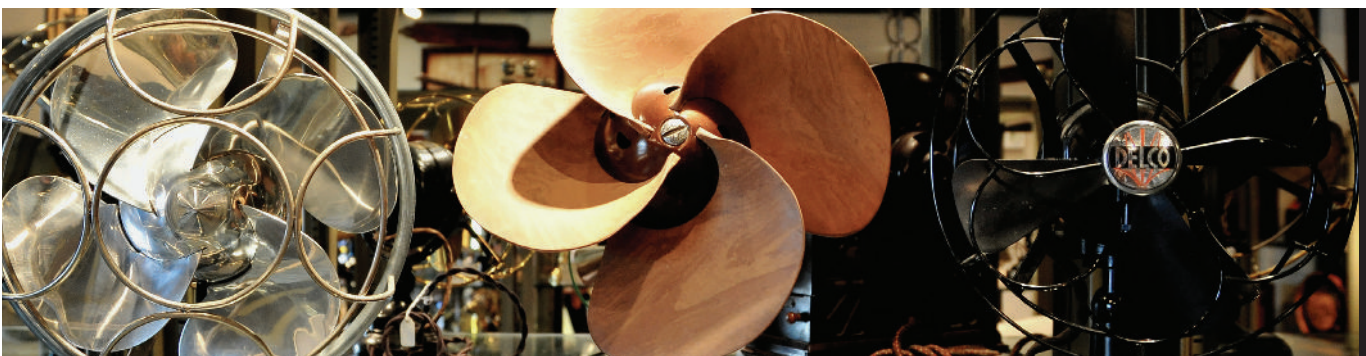





## LOCATION

10983 Bennett Parkway  
Zionsville, IN 46077



## HOURS

Monday thru Friday 10 am - 4 pm  
Or call for an appointment, 317-733-4113



## MUSEUM HIGHLIGHTS

- The AFCA museum contains more than 1,000 antique ceiling, desk and hand fans with over 140 manufacturers represented
- The oldest electric desk fan in the museum dates from the early 1890's
- The oldest non-electric fans (steam, belt & pulley or water powered) date from the early 1880's.
- It is the only antique fan museum open to the public in the world
- The AFCA has approximately 700 members worldwide
- The museum contains some of the earliest battery-powered fans, water-powered fans, wind-up fans, electric hand-held fans, ceiling fans, wall fans, desk fans, pedestal fans, rail-car fans and fans that don't even look like fans.
- The museum contains hundreds of hand-held fans that feature advertising from manufactures, retailers, politicians and movie stars.



## INDEX

<b>FANS</b>	<b>PAGE</b>
A1**	65, 66
BP200**1	95, 96
BP210**1	95, 96
BP215OB1	95, 96
BP220**1	95, 96
BP225OB1	95, 96
BP230**1	95, 96
C1**	65, 66
D1**	67, 72
FP10**	127, 128
FP1280**	127, 128
FP20**	127, 128
FP2120MG	59, 60
FP240**	121, 122
FP320**1	113, 114
FP410**	119, 120
FP420**	119, 120
FP4320**1	111, 112
FP4620**	21, 22
FP4630SN	21, 22
FP4640**	73, 74
FP4650**	75, 76
FP510**	53, 54
FP520**	53, 54
FP540**	53, 54
FP580**	53, 54
FP601**	53, 54
FP602**	53, 54
FP603**	53, 54
FP604**	53, 54
FP605**	53, 54
FP6210**	91, 92
FP6244**	41, 42
FP6245**	41, 42
FP6252BN	131, 132
FP6284**	43, 44
FP6285**	43, 44
FP6717**	61, 62
FP6728**	63, 64
FP7000OB	123, 124
FP720**	125, 126
FP7500**	107, 108
FP780**	125, 126
FP7900**	87, 88
FP7902BN	89, 90
FP7910**	25, 26
FP7954OB	105, 106
FP7958**	133, 134
FP7963RS	103, 104

<b>FANS</b>	<b>PAGE</b>
FP7964**	17, 18
FP8003**	29, 30
FP8012**	101, 102
FP8014**	135, 136
FP8016OB	101, 102
FP8026**	19, 20
FP8032DZ	35, 36
FP8042**	39, 40
FP8062**	23, 24
FP8095**	31, 32
FDP6236**	77, 78
FDP7916**	81, 82
FDP7943**	93, 94
FDP8088**	33, 34
FDP8089**	33, 34
FDP8149***	79, 80
FPH210**	137, 138
FPH21BL	137, 138
FPH61**	137
FPH70**	137, 138
FPH81**1	137
FPS7880**	16, 17
FPS7955**	13, 14
FPS7981**	11, 12
HA7966**	51, 52
MA6721**	85, 86
MA7500**	109, 110
MA7966**	51, 52
MAD3250**	115, 116
MAD3252**	117, 118
MAD3255**	37, 38
MAD7912**	83, 84
OF110**	57, 58
PL8274**	27, 28
TF610**	45, 46
TF710**	47, 48
TF721**	49, 50
TF910**	97, 98
TF971**	99, 100

<b>LIGHT KITS</b>	<b>PAGE</b>
LK112A	139
LK113WH	139
LK114AOB	139
LK122A	139
LK124A**	139
LK124WTS	139
LK250	139
LK260	139

<b>LIGHT KITS</b>	<b>PAGE</b>
LK4640**	73
LK6721**	85, 86
LK7912**	83, 84
LKLP101**	139
LKLP102**	109, 139
LKLP111AOB	139
LKLP111WWH	139
LKLP112AOB	139
LKLP112WSN	139

<b>FITTERS</b>	<b>PAGE</b>
F1**	67, 71
F2**	65, 66, 67, 71, 72
F3**	65, 71
F4**	65, 67, 71
F423**	115, 140
FW423**	140

<b>GLASS &amp; SHADES</b>	<b>PAGE</b>
G1**	65, 67, 71
G100*	140
G2**	66, 67, 71
G210	140
G235	140
G239	140
G244	140
G250	140
G256	140
G3**	65, 71, 72
G4**	67, 71
G439	115, 140
G450	115, 140
G451	140
G456	140
G5**	65, 71
G6**	71

<b>BLADES</b>	<b>PAGE</b>
B154**	67, 70
B160**	70
B172**	65, 70, 72
B254**	65, 70
B260**	67, 70
B272**	70
B354**	70
B360**	67, 70
B372**	70
B4400SN	21, 75
B4442SN	21, 75

<b>BLADES</b>	<b>PAGE</b>	<b>BLADES</b>	<b>PAGE</b>	<b>CONTROLS</b>	<b>PAGE</b>
B454**	70	CABPP4**	123, 150	SW24**	142
B460**	65, 70	CAISD2A	123, 149	SW70OB	142
B472**	70	CAISD4A	149	TR205	71, 141, 145
B5080**	121, 122	CAISP4	149	TR20WH	142, 145
B5133TKMH	38, 113, 150	FP1018	53, 119, 120	TR22WH	145
B5213WA	121, 123, 150	FP1022	127	TR24WH	142, 145
B5280WA	109, 149	FP1026	127, 128	TR33WH	145
B5300WA	117, 150	FP1030	127	TR39	145
B5330WA	150	ISD1A	109, 113, 115, 149	TR41	145
B5340WA	109, 111, 149	ISD4A	37, 116, 149	TW206	71, 144, 145
B5350WA	150	ISP1	37, 113, 114, 115, 149	TW40**	144, 145
B554**	70	ISP4	115, 149	WP60	73, 145
B560**	65, 70	PAD1A	121, 149		
B6080WA	149	PAD1C	121, 149	<b>ACCESSORIES</b>	<b>PAGE</b>
B6130WA	150	PAD2A	149	CCK8002**	109, 148
B6133TKMH	150	PAP1	149	CCK8002**W	148
B654**	66, 67, 70	PMD2AAB	54, 149	DR1-12**	147
B660**	70	PMD2ABL	149	DR1-12**W	147
B6720**	85, 86	PMP2AB	149	DR1-18**	147
B6801**	117	PMP2BL	149	DR1-18**W	147
B6831WA	117, 118	PUD1A	125, 149	DR1-24**	147
B6841DWA	117	PUD1C	149	DR1-24**W	147
B754DWA	65, 70	PUP1	125, 126, 149	DR1-36**	147
B760DWA	70			DR1-36**W	147
B7880SN	15	<b>CONTROLS</b>	<b>PAGE</b>	DR1-48**	147
B7912**	83	BTCR9	141, 146	DR1-48**W	147
B7913**	83, 84	BTCR9U	141, 146	DR1-60**	147
B7914**	83	BTR9	141, 146	DR1-60**W	147
B7966**	51, 52	BTR9U	141, 146	DR1-6OB	147
B854**	70	BTT9	141, 146	DR1-72**	147
B860**	67, 70	BTT9U	141, 146	DR1-72**W	147
BEW42WALW	45, 47	C21	144, 145	DR1-CP**	147
BMD4A	127, 149	C23	145	DRS24TR	148
BMP1	127, 149	C25	144, 145	EP24**	147
BPD1A	149	C4	142, 145	EP30**	147
BPD4**	111, 115, 149	CH1**	142, 145	EP36**	147
BPP1**	150	CRL4**	142, 145	EP48**	147
BPP4**	111, 119, 150	CRL8TS	142, 145	EP60**	147
BPW20CY	109, 113, 150	CW1**	144, 145	EP72**	147
BPW24MW	150	CW110WH	144, 145	EPCP**	147
BPW4426**	21, 73, 75	CW1SW**	143, 145	FL**	121
BPW4442**	21, 75	CW2**	143, 145	P48	121
BPW6000**	117	CW3WH	143, 145	SCB1-52	147
BPW6030**	150	CW3WH-CA	143, 145	SCK1-52**	147
BPW6090DNA	109, 110, 112, 115, 150	CW5**	143, 145		
BPW7823**	15	CW60WH	73, 144, 145		
BPW7880**	15, 16	CW6WH	143, 145		
BPW7912**	83	CWRL4**	144, 145		
CABPD4A	149	RC110WH	142, 145		

 **FANIMATION**<sup>®</sup>  
C E I L I N G F A N S

 888.567.2055

 [fanimation.com](http://fanimation.com)

 [fanimation](https://www.facebook.com/fanimation)

 [fanimation](https://twitter.com/fanimation)

 [fanimationfans](https://www.pinterest.com/fanimationfans)

 [fanimationfan](https://www.youtube.com/fanimationfan)

 10983 Bennett Parkway, Zionsville, Indiana 46077

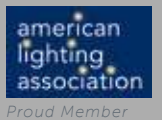

LTFC0116  
JANUARY 2016